



## Cellular Shades

2024 Price Guide

Effective May 1st, 2024

Custom Cellular  
Cellular Sliders  
Simply Cordless



## FREIGHT POLICY

### STANDARD SHIPPING & HANDLING, DELIVERY & FREIGHT POLICIES:

- \$8.00 freight charge per unit for the cellular shade.
- The minimum freight charge is \$20.00 per order.
- Oversize (94" or above) charge is \$110.00 per shipment without quantity limit. Oversize charge is in addition to the freight charge.
- For the express shipment, shipment to Alaska, Hawaii and foreign countries, freight will be quoted separately.
- Freight collect and using preferred carrier is optional.
- Next Day, 2nd Day Air and 3 Day select shipping options are available. Actual freight will be applied.

### FREIGHT DAMAGE AND SHORTAGES:

Please inspect all shipments immediately and carefully. Please report the damages and shortages on the delivery receipt and notify WWC customer service within 48 hours. No freight damage claim will be accepted after 30 days from shipping.

## REPAIR NET SURCHARGES

REPAIRING SERVICES	NET SURCHARGE/ PER SHADE
Shorten the shade height	\$20.00
Cut down the width	\$20.00
Restrung	\$25.00
Change control position	\$25.00
Replace the headrail, middle rail, or bottom rail	\$25.00

CELLULAR OPTION CHANGES	NET SURCHARGE/ PER SHADE
If the new shade costs more than original shade	45.00 plus cost difference per shade
If the new shade costs less than original shade	\$45.00 standard per shade



<b>MINIMUM REPAIR CHARGE (NET)</b>	<b>\$30.00</b>
------------------------------------	----------------

**\*\*NOTE:** All repair charges do not include freight. Standard shipping charges will be applied.

## RUSH ORDER NET SURCHARGES

- The rush order is subject to inventory availability and the production schedule.
- Same day production rush must be submitted by 10 a.m. Pacific Time to be processed on that business day.
- 24- and 48-hour rush orders must be submitted by 2:30 p.m. Pacific Time to be processed on that business day

RUSH OPTIONS	NET SURCHARGE/ PER SHADE
Same day production rush	\$45.00
24-hour rush	\$18.00
48-hour rush	\$10.00

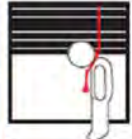
 <b>WARNING</b>  <b>ADVERTENCIA</b>		<p><b>Window Blind Cord Strangulation Risk</b></p> <p>Window blinds with a damaged or loose tension device or retractable cord that fails to fully retract pose a strangulation risk to children. To avoid this potential strangulation risk, consider purchasing cordless products or products with inaccessible cords</p>
--	---	---

# Custom Cellular Fabric Selections and Color Coordination - I

Western Window Coverings cellular shade collection is one of the most fashionable and comprehensive in the industry. We offer a variety of single cell, cell-in-a cell, and double cell cellular shade fabrics, from light filtering to blackout, in neutral tonal shades to rich pigment tones. Specialty fabrics such as sheer, whisper woven, slub woven, designer prints, and LUX Linen offer a diverse range of options. Fire retardant fabrics are also available for commercial use.

Standard rail size for each fabric		Fabrics			
		1-1/4" Single Cell	3/4" Single Cell	9/16" Single Cell	7/16" Double Cell
Rail Size	Headrail	3/4"	3/4"	9/16"	9/16"
	Middle rail	3/4"	3/4"	9/16"	9/16"
	Bottom rail	3/4"	3/4"	9/16"	9/16"

\* Check out page "Headrail Features and Comparisons" for more details.

## FABRICS AND COLOR COORDINATED COMPONENTS - 3/4"

3/4" Single Cell Light Filtering		Rail Color Code	Slider Rail Color Code
PS410-001	Cotton	001	593
PS410-002	Snow White	002	593
PS410-003	Onion	006	593
PS410-004	Alabaster	006	593
PS410-005	Cream	006	593
PS410-006	Fawn	006	593
PS410-007	Biscuit	008	593
PS410-008	Pongee	008	593
PS410-009	Ocher	010	593
PS410-010	Tan	010	593
PS410-011	Terra Cotta	326	593
PS410-012	Cocoa	012	593
PS410-013	Spring Green	002	593
PS410-014	Water Green	015	593
PS410-015	Avocado	015	593
PS410-016	Roseate	016	593
PS410-019	Agate Red	020	593
PS410-020	Bordeaux	020	593
PS410-021	Gray Sheen	091	091
PS410-022	Marine Blue	091	091
PS410-023	Royal Gray	023	091
PS410-024	Jean Blue	023	025
PS410-025	Black	025	025
PS410-026	Wisteria	091	091
PS410-030	Anthracite	025	025
PS410-069	White Dove	001	593
PS410-070	Winter White	002	593
PS410-326	Dark Chocolate	326	025
PS410-346	Antique Pewter	025	025
PS410-470	Slate	025	025
PS410-519	Stone	012	593
PS410-786	Greige	002	593
PS410-788	Pale Slate	091	091

3/4" Single Cell Linen Print Light Filtering		Rail Color Code	Slider Rail Color Code
PS431-012	Cocoa	012	593
PS431-032	Sand	006	593
PS431-034	Gray	091	091
PS431-326	Dark Chocolate	326	025
PS431-514	Misty Gray	002	593

3/4" Single Cell Smooth Light Filtering		Rail Color Code	Slider Rail Color Code
PS43C-001	Cotton	001	593
PS43C-002	Snow White	002	593
PS43C-005	Cream	006	593
PS43C-070	Winter White	006	593

3/4" Single Cell Bamboo Print Light Filtering		Rail Color Code	Slider Rail Color Code
PS41RA-023	Royal Gray	091	091
PS41RA-346	Antique Pewter	091	091
PS41RA-514	Misty Gray	002	593
PS41RA-519	Stone	012	593
PS41RA-583	Dark Gray Sheen	091	091

3/4" Single Cell Tweed Print Light Filtering		Rail Color Code	Slider Rail Color Code
PS413-069	White Dove	001	593
PS413-004	Alabaster	006	593
PS413-514	Misty Gray	002	593
PS413-583	Dark Gray Sheen	091	091
PS413-344	Pebble	025	025

3/4" Single Cell Sheer Light Filtering		Rail Color Code	Slider Rail Color Code
PS460-001	Cotton	001	593
PS460-004	Alabaster	006	593

- The rail color code applies to rails, end caps, and clutches.
- The slider rail comes with 3 colors, including vanilla #593, transparent aluminum #091, and black #025.
- The list above is the standard color coordination chart applied in the manufacturer's production line. A different color of rails is available upon request, please specify it on the PO. The actual rail swatches are available on the cellular shade sample book.

# Custom Cellular Fabric Selections and Color Coordination - II

## FABRICS AND COLOR COORDINATED COMPONENTS - 3/4"

3/4" Cell-In-A Cell Light Filtering		Rail Color Code	Slider Rail Color Code
PU41SS-001	Cotton	001	593
PU41SS-763	Taupe	002	593
PU41SS-764	Beige	002	593
PU41SS-765	Ivory	002	593
PU41SS-766	Classic Gray	091	091
PU41SS-823	Blue Wind	091	091
PU41SS-824	Gray Storm	091	091
PU41SS-025	Black	025	025
PU41SSA-519	Bamboo Print Ston	012	593
PU41SSA-346	Bamboo Print Antique Pewter	091	091

3/4" Single Cell Whisper Woven Light Filtering		Rail Color Code	Slider Rail Color Code
PS47K0-001	Cotton	001	593
PS47K0-006	Fawn	006	593
PS47K0-583	Feather Gray	091	091
PS47K0-823	Blue Wind	091	091
PS47K0-824	Gray Storm	091	091

3/4" Single Cell LUX Linen Light Filtering		Rail Color Code	Slider Rail Color Code
PS47B0-901	Porcelain	001	593
PS47B0-919	Camel	006	593
PS47B0-921	Stonington Gray	091	091
PS47B0-930	Charcoal	025	025
PS47B0-992	Hazelnut	012	593

3/4" Single Cell Slub Woven Light Filtering		Rail Color Code	Slider Rail Color Code
PS47S-001	Cotton	001	593
PS47S-004	Alabaster	006	593
PS47S-012	Cocoa	012	593
PS47S-021	Gray Sheen	091	091
PS47S-326	Dark Chocolate	326	025

3/4" Single Cell Bamboo Print Blackout		Rail Color Code	Slider Rail Color Code
PS42RA-023	Royal Gray	091	091
PS42RA-346	Antique Pewter	091	091
PS42RA-514	Misty Gray	002	593
PS42RA-519	Stone	012	593
PS42RA-583	Dark Gray Sheen	091	091

3/4" Single Cell Linen Print Blackout		Rail Color Code	Slider Rail Color Code
PS441-012	Cocoa	012	593
PS441-032	Sand	006	593
PS441-034	Gray	091	091
PS441-326	Dark Chocolate	326	025
PS441-514	Misty Gray	002	593

3/4" Single Cell Blackout		Rail Color Code	Slider Rail Color Code
PS420-001	Cotton	001	593
PS420-002	Snow White	002	593
PS420-003	Onion	006	593
PS420-004	Alabaster	006	593
PS420-006	Fawn	006	593
PS420-008	Pongee	008	593
PS420-009	Ocher	010	593
PS420-012	Cocoa	012	593
PS420-015	Avocado	015	593
PS420-020	Bordeaux	020	593
PS420-021	Gray Sheen	091	091
PS420-024	Jean Blue	023	025
PS420-025	Black	025	025
PS420-030	Anthracite	025	025
PS420-069	White Dove	001	593
PS420-070	Winter White	002	593
PS420-326	Dark Chocolate	326	025
PS420-346	Antique Pewter	025	025
PS420-470	Slate	025	025

3/4" Single Cell Smooth Blackout		Rail Color Code	Slider Rail Color Code
PS44C-002	Snow White	002	593
PS44C-005	Cream	006	593
PS44C-021	Gray Sheen	001	593
PS44C-070	Winter White	001	593

3/4" Cell-In-A Cell Light Filtering		Rail Color Code	Slider Rail Color Code
PU42SS-001	Cotton	001	593
PU42SS-763	Taupe	002	593
PU42SS-764	Beige	002	593
PU42SS-765	Ivory	002	593
PU42SS-766	Classic Gray	091	091
PU42SS-823	Blue Wind	091	091
PU42SS-824	Gray Storm	091	091
PU42SS-025	Black	025	025
PU42SSA-519	Bamboo Print Stone	012	593
PU42SSA-346	Bamboo Print Antique Pewter	091	091

3/4" Single Cell Tweed Print Blackout		Rail Color Code	Slider Rail Color Code
PS423-069	White Dove	001	593
PS423-004	Alabaster	006	593
PS423-514	Misty Gray	002	593
PS423-583	Dark Gray Sheen	091	091
PS423-344	Pebble	025	025

- The rail color code applies to rails, end caps, and clutches.
- The slider rail comes with 3 colors, including vanilla #593, transparent aluminum #091, and black #025.
- The list above is the standard color coordination chart applied in the manufacturer's production line. A different color of rails is available upon request, please specify it on the PO. The actual rail swatches are available on the cellular shade sample book.

# Custom Cellular Fabric Selections and Color Coordination - III

Fabric Selections

## FABRICS AND COLOR COORDINATED COMPONENTS - 9/16", 7/16", AND 1-1/4"

9/16" Single Cell Light Filtering		Rail Color Code	Slider Rail Color Code
PS310-001	Cotton	001	593
PS310-002	Snow White	002	593
PS310-003	Onion	006	593
PS310-004	Alabaster	006	593
PS310-005	Cream	006	593
PS310-006	Fawn	006	593
PS310-007	Biscuit	008	593
PS310-008	Pongee	008	593
PS310-009	Ocher	010	593
PS310-010	Tan	010	593
PS310-011	Terra Cotta	326	593
PS310-012	Cocoa	012	593
PS310-013	Spring Green	002	593
PS310-014	Water Green	015	593
PS310-015	Avocado	015	593
PS310-016	Roseate	016	593
PS310-019	Agate Red	020	593
PS310-020	Bordeaux	020	593
PS310-021	Gray Sheen	091	091
PS310-022	Marine Blue	091	091
PS310-023	Royal Gray	023	091
PS310-024	Jean Blue	023	025
PS310-025	Black	025	025
PS310-026	Wisteria	091	091
PS310-030	Anthracite	025	025
PS310-069	White Dove	001	593
PS310-070	Winter White	002	593
PS310-346	Antique Pewter	025	025
PS310-470	Slate	025	025
PS310-326	Dark Chocolate	326	025

9/16" Single Cell Linen Print Light Filtering		Rail Color Code	Slider Rail Color Code
PS331-012	Cocoa	012	593
PS331-032	Sand	006	593
PS331-034	Gray	091	091
PS331-326	Dark Chocolate	326	025
PS331-514	Misty Gray	002	593

9/16" Single Cell Slub Woven Light Filtering		Rail Color Code	Slider Rail Color Code
PS375-001	Cotton	001	593
PS375-004	Alabaster	006	593
PS375-012	Cocoa	012	593
PS375-021	Gray Sheen	091	091
PS375-326	Dark Chocolate	326	025

9/16" Single Cell Fire Retardant Light Filtering		Rail Color Code	Slider Rail Color Code
PS310-001FR	Cotton	001	593
PS310-006FR	Fawn	006	593
PS310-008FR	Pongee	008	593
PS310-070FR	Winter White	002	593

1-1/4" Single Cell Light Filtering		Rail Color Code	Slider Rail Color Code
PS610-001	Cotton	001	593
PS610-006	Fawn	006	593
PS610-021	Gray Sheen	091	091

7/16" Double Cell Light Filtering		Rail Color Code	Slider Rail Color Code
PX3A0-001	Cotton	001	593
PX3A0-069	White Dove	001	593
PX3A0-070	Winter White	002	593
PX3A0-002	Snow White	002	593
PX3A0-004	Alabaster	006	593
PX3A0-005	Cream	006	593
PX3A0-006	Fawn	006	593
PX3A0-007	Biscuit	008	593
PX3A0-008	Pongee	008	593
PX3A0-009	Ocher	010	593
PX3A0-010	Tan	010	593
PX3A0-012	Cocoa	012	593
PX3A0-016	Roseate	016	593
PX3A0-020	Bordeaux	020	593
PX3A0-021	Gray Sheen	091	091
PX3A0-023	Royal Gray	023	091
PX3A0-024	Jean Blue	023	025
PX3A0-025	Black	025	025
PX3A0-326	Dark Chocolate	326	025

9/16" Single Cell Blackout		Rail Color Code	Slider Rail Color Code
PS320-001	Cotton	001	593
PS320-002	Snow White	002	593
PS320-003	Onion	006	593
PS320-004	Alabaster	006	593
PS320-006	Fawn	006	593
PS320-008	Pongee	008	593
PS320-009	Ocher	010	593
PS320-012	Cocoa	012	593
PS320-015	Avocado	015	593
PS320-020	Bordeaux	020	593
PS320-021	Gray Sheen	091	091
PS320-024	Jean Blue	023	025
PS320-025	Black	025	025
PS320-069	White Dove	001	593
PS320-070	Winter White	002	593
PS320-326	Dark Chocolate	326	025
PS320-346	Antique Pewter	025	025
PS320-470	Slate	025	025











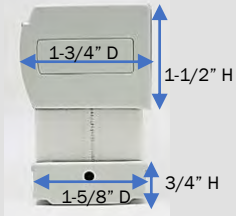

9/16" Single Cell Fire Retardant Blackout		Rail Color Code	Slider Rail Color Code
PS320-001FR	Cotton	001	593
PS320-006FR	Fawn	006	593
PS320-008FR	Pongee	008	593
PS320-070FR	Winter White	002	593

1-1/4" Single Cell Blackout		Rail Color Code	Slider Rail Color Code
PS620-001	Cotton	001	593
PS620-006	Fawn	006	593
PS620-021	Gray Sheen	091	091

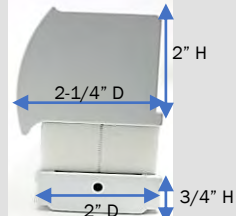
- The rail color code applies to rails, end caps, and clutches.
- The slider rail comes with 3 colors, including vanilla #593, transparent aluminum #091, and black #025.
- The list above is the standard color coordination chart applied in the manufacturer's production line. A different color of rails is available upon request, please specify it on the PO. The actual rail swatches are available on the cellular shade sample book.

# Headrail Features and Comparisons

Fabric	9/16" Single Cell & 7/16" Double Cell		3/4 " Single Cell & Cell-in-a Cell		1-1/4" Single Cell	
Feature	Standard	Upgrade	Standard	Optional	Standard	Optional
Headrail size	<b>9/16"</b>	<b>3/4"</b> (Please make a note on the PO)	<b>3/4"</b>	<b>9/16"</b> (Please make a note on the PO)	<b>3/4"</b>	<b>9/16"</b> (Please make a note on the PO)
Pricing	Regular Price	<b>\$24 (MSRP)/ per shade</b>	Regular Price	No additional charge	Regular Price	No additional charge
Bottom rail	9/16"	9/16"	3/4"	3/4"	3/4"	3/4"
Middle rail	9/16"	9/16"	3/4"	3/4"	3/4"	3/4"
Fabric insert for TDBU shades	Yes	No	No	Yes	No	Yes
Minimum mounting space	7/8"	1/2"	1/2"	7/8"	1/2"	7/8"
Flush mounting space	2"	2-1/2"	2-1/2"	2-1/8"	2-5/8"	2-1/2"
Available operating systems	<ul style="list-style-type: none"> <li>• Cordless, Cordless Top Down Bottom Up, Cordless Day/Night</li> <li>• Clutch, Clutch Top Down Bottom Up, Clutch Day/Night</li> <li>• Motorizations - Simple Touch Regular, Simple Touch Top Down Bottom Up, Somfy Regular, Rollease Regular, and Rollease Top Down Bottom Up (except motorized skylight)</li> </ul> <p>Note - The headrail of the Simple Touch Wand is only available with a 9/16" headrail.</p>					
Number of the rail colors	13 colors					

Fabric	9/16" Single Cell & 7/16" Double Cell		3/4 " Single Cell & Cell-In-A Cell	1-1/4" Single Cell
Standard Headrail	9/16"	3/4"	3/4"	3/4"
Front view				
Side view				
Installation bracket				

Stacking Chart: The chart below is including heights of the headrail and bottom rail with the cordless system											R Value	
Fabric Type	36" Drop	48" Drop	60" Drop	72" Drop	84" Drop	96" Drop	108" Drop	120" Drop	132" Drop	144" Drop		
3/4" Single Cell	Light Filtering	3.42	3.64	3.87	4.09	4.32	4.54	4.77	4.99	4.99	5.22	3.8
	Blackout	3.26	3.43	3.60	3.77	3.94	4.12	4.29	4.48	4.65	4.82	4.4
	Linen Print LF	3.39	3.55	3.71	3.86	4.02	4.18	4.34	4.49	4.66	4.81	3.6
	Linen Print BO	3.30	3.42	3.55	3.67	3.80	3.94	4.06	4.20	4.32	4.45	4.2
	Bamboo Print LF	3.42	3.64	3.87	4.09	4.32	4.54	4.77	4.99	4.99	5.22	3.8
	Bamboo Print BO	3.26	3.43	3.60	3.77	3.94	4.12	4.29	4.48	4.65	4.82	4.4
	Tweed Print LF	3.42	3.64	3.87	4.09	4.32	4.54	4.77	4.99	4.99	5.22	3.8
	Tweed Print BO	3.26	3.43	3.60	3.77	3.94	4.12	4.29	4.48	4.65	4.82	4.4
	Smooth LF	3.13	3.25	3.38	3.50	3.63	3.75	3.88	4.00	4.13	4.25	3.7
	Smooth BO	2.90	2.98	3.06	3.14	3.22	3.30	3.39	3.47	3.56	3.64	4.4
	LUX Linen LF	3.31	3.53	3.76	3.98	4.21	4.43	4.66	4.88	5.11	5.33	2.8
	Slub Woven LF	3.48	3.67	3.82	4.01	4.17	4.32	4.48	4.67	4.82	5.01	2.8
	Whisper Woven LF	3.23	3.36	3.46	3.57	3.68	3.80	3.90	4.02	4.14	4.25	2.7
Sheer LF	3.38	3.54	3.72	3.87	4.04	4.18	4.33	4.48	4.65	4.80	2.2	
3/4" Cell-In-A Cell	Light Filtering	4.32	4.74	5.16	5.58	6.01	6.09	6.49	6.93	7.33	9.57	4.3
	Blackout	4.14	4.51	4.88	5.25	5.62	5.84	6.21	6.62	6.99	7.39	4.7
9/16"	Light Filtering	2.88	3.13	3.38	3.68	3.88	4.18	4.38	4.70	4.88	5.20	3.5
	Blackout	2.69	2.88	3.06	3.25	3.44	3.63	3.81	4.00	4.19	4.38	4.3
	Linen Print LF	3.00	3.25	3.50	3.75	4.00	4.25	4.50	4.75	5.00	5.25	3.5
	Slub Woven LF	3.13	3.42	3.71	4.00	4.29	4.58	4.88	5.17	5.46	5.75	2.8
	Fire Retardant LF	2.80	3.01	3.18	3.35	3.52	3.69	3.86	4.04	4.21	4.38	3.5
	Fire Retardant BO	2.74	2.91	3.09	3.25	3.39	3.54	3.68	3.83	3.97	4.13	4.3
1-1/4" Single Cell	Light Filtering	3.27	3.43	3.61	3.80	3.96	4.15	4.31	4.49	4.65	4.89	3.9
	Blackout	2.95	3.03	3.12	3.21	3.29	3.38	3.46	3.56	3.63	3.76	4.5
7/16" Double Cell	Light Filtering	3.44	3.75	4.06	4.40	10.62	5.42	5.77	5.77	6.12	6.47	3.6

Note: The measurement of stacking height includes the height of the standard headrail (3/4" or 9/16" headrail) for each fabric. The sizes of headrails are listed on the previous page. All stacking sizes are approximate.

\* LF stands for the light filtering fabric; BO stands for the blackout fabric.

Mounting Space							
Cell Size	Mount Space By The Headrail Type		Clutch	Clutch TDBU	Cordless	Cordless TDBU	Motorization
9/16" & 7/16"	9/16" headrail (standard)	Minimum mounting space	7/8"	7/8"	7/8"	7/8"	7/8"
		Minimum flush mounting space	2"	2"	2"	2"	2"
	3/4" headrail	Minimum mounting space	1/2"	1/2"	1/2"	1/2"	1/2"
		Minimum flush mounting space	2-1/2"	2-1/2"	2-1/2"	2-1/2"	2-1/2"
3/4"	9/16" headrail	Minimum mounting space	7/8"	7/8"	7/8"	7/8"	7/8"
		Minimum flush mounting space	2-1/8"	2-1/8"	2-1/8"	2-1/8"	2-1/8"
	3/4" headrail (standard)	Minimum mounting space	1/2"	1/2"	1/2"	1/2"	1/2"
		Minimum flush mounting space	2-1/2"	2-1/2"	2-1/2"	2-1/2"	2-1/2"
1-1/4"	9/16" headrail	Minimum mounting space	7/8"	7/8"	7/8"	7/8"	7/8"
		Minimum flush mounting space	2-1/2"	2-1/2"	2-1/2"	2-1/2"	2-1/2"
	3/4" headrail (standard)	Minimum mounting space	1/2"	1/2"	1/2"	1/2"	1/2"
		Minimum flush mounting space	2-5/8"	2-5/8"	2-5/8"	2-5/8"	2-5/8"

Note. For the minimum mounting space of 1/2", it is required to use #4 x 3/4" flat head screws that are not included in the hardware package.

Continuous Cord Length	
Shade Height	Length
< 40"	2 feet
40" - 57.9"	3 feet
58" - 72.9"	4 feet
73" - 85.9"	5 feet
86" - 107.9"	6 feet
≥ 108"	8 feet

Headrail Bracket Quantity	
Shade Width	Quantity
7" ~ 36"	2
36.1" ~ 72"	3
72.1" ~ 96"	4
96.1" ~ 120"	5
120.1" ~ 144"	6

\* Product specification is subject to change without notice.

Base Price Group Chart

Base Price Group Chart/ By Fabric Type		Price Group	
3/4"	Single Cell	Light Filtering Smooth	1
		Light Filtering Linen Print	2
		Light Filtering	3
		Light Filtering Bamboo Print	3
		Light Filtering Tweed Print	3
		Light Filtering Whisper Woven	8
		Light Filtering Sheer	8
		Light Filtering Slub Woven	9
		Light Filtering LUX Linen	9
		Blackout Smooth	5
		Blackout Linen Print	6
		Blackout	7
		Blackout Bamboo Print	7
		Blackout Tweed Print	7
	Cell-In-A Cell	Light Filtering	8
	Blackout	10	
9/16"	Single Cell	Light Filtering Linen Print	1
		Light Filtering	2
		Light Filtering Fire Retardant	5
		Light Filtering Slub Woven	9
		Blackout	6
	Blackout Fire Retardant	9	
1-1/4"	Single Cell	Light Filtering	3
		Blackout	7
7/16"	Double Cell	Light Filtering	4

3/4" – Single Cell Light Filtering Smooth (PS43C)												BASE PRICE GROUP 1			
9/16" – Single Cell Light Filtering Linen Print (PS331)															
WIDTH TO:	7"- 24"	30"	36"	42"	48"	54"	60"	66"	72"	84"	96"	108"	120"	132"	144"
5" - 36"	146	168	192	217	239	268	293	318	345	399	451	503	556	609	660
42"	157	182	209	238	263	294	324	353	381	441	501	558	618	677	734
48"	167	196	224	256	283	320	349	383	416	480	545	609	676	742	805
54"	183	214	247	280	312	349	384	422	457	528	599	670	743	814	884
60"	197	230	268	303	335	379	416	456	493	570	649	726	802	880	957
66"	212	248	287	325	363	407	447	490	531	615	699	780	868	949	1033
72"	225	263	306	348	388	435	480	525	569	657	750	837	928	1017	1107
78"	237	279	323	367	416	462	511	559	607	702	799	892	989	1085	1180
84"	246	292	341	387	436	486	537	588	637	736	840	939	1045	1146	1248
90"	258	307	358	408	459	514	565	620	676	781	888	996	1104	1210	1318
96"	269	321	373	426	480	537	594	651	706	818	932	1043	1158	1270	1383
108"	293	348	407	466	526	589	651	712	775	898	1023	1145	1273	1395	1519
120"	313	378	442	508	574	642	708	778	843	977	1114	1248	1386	1520	1656
132"	334	405	474	546	619	692	766	838	911	1059	1206	1350	1500	1642	1789
144"	357	432	509	586	664	744	822	900	979	1137	1295	1453	1614	1767	1926

Manufacturer's suggested retail price

Notes

- The 2-on-1 and 3-on-1 headrail option is strongly recommended for the shades measuring 96" or more in width or height.
- Product price only, not including freight, taxes, and other surcharges associated with the custom shade/ requests.
- Base prices apply to cordless and clutch shades. Please check the surcharges for the different operating systems.



3/4" – Single Cell Light Filtering Linen Print (PS431) 9/16" – Single Cell Light Filtering (PS310)												BASE PRICE GROUP <b>2</b>				
WIDTH TO:	7" - 24"	30"	36"	42"	48"	54"	60"	66"	72"	84"	96"	108"	120"	132"	144"	
HEIGHT TO:	5" - 36"	165	190	217	246	272	305	333	361	391	453	513	570	633	693	750
	42"	178	207	237	271	299	334	369	400	433	502	568	634	702	769	834
	48"	189	222	255	291	322	363	397	435	472	546	619	693	769	843	915
	54"	207	243	280	318	354	397	436	480	518	600	680	761	845	924	1004
	60"	224	261	304	344	382	430	472	517	561	649	736	825	912	1000	1089
	66"	241	281	325	370	413	463	507	556	603	698	795	887	986	1078	1173
	72"	256	298	347	396	441	494	545	597	646	748	853	951	1056	1155	1258
	78"	269	318	367	417	472	525	581	636	690	798	907	1014	1125	1234	1341
	84"	280	332	387	441	496	552	610	668	724	837	954	1068	1188	1302	1417
	90"	293	349	406	463	522	584	642	705	768	888	1008	1131	1254	1376	1497
	96"	306	364	424	484	546	610	675	738	802	930	1059	1185	1317	1443	1572
	108"	333	396	463	529	598	669	739	810	880	1020	1162	1300	1446	1585	1726
	120"	357	429	504	577	652	730	805	883	959	1111	1266	1419	1575	1728	1881
	132"	380	459	539	620	704	786	870	952	1036	1203	1370	1534	1704	1866	2033
144"	406	492	579	666	755	846	934	1023	1113	1293	1471	1650	1833	2008	2188	

Manufacturer's suggested retail price

3/4" – Single Cell Light Filtering (PS410) 3/4" – Single Cell Light Filtering Bamboo Print (PS41RA) 3/4" – Single Cell Light Filtering Tweed Print (PS413) 1-1/4" – Single Cell Light Filtering (PS610) *												BASE PRICE GROUP <b>3</b>				
WIDTH TO:	7" - 24"	30"	36"	42"	48"	54"	60"	66"	72"	84"	96"	108"	120"	132"	144"	
HEIGHT TO:	5" - 36"	178	205	235	267	294	329	360	390	423	489	553	616	682	748	810
	42"	193	223	256	293	324	361	398	433	468	542	615	685	758	831	900
	48"	205	240	275	314	348	392	430	470	510	589	669	748	830	910	988
	54"	223	262	303	344	382	429	471	519	559	646	735	822	912	998	1084
	60"	242	282	328	371	412	465	510	559	606	700	796	891	985	1080	1175
	66"	259	304	352	399	446	500	547	601	652	753	858	958	1065	1164	1267
	72"	276	323	375	427	477	533	589	644	698	808	921	1027	1139	1247	1359
	78"	296	350	404	459	520	578	640	700	760	878	999	1117	1239	1359	1477
	84"	308	366	426	486	546	608	673	736	798	921	1052	1176	1308	1434	1562
	90"	323	385	448	510	574	643	708	776	846	978	1110	1245	1381	1515	1650
	96"	336	402	468	533	601	673	743	813	883	1024	1167	1306	1450	1590	1731
	108"	367	435	510	582	658	736	814	892	970	1124	1280	1432	1593	1746	1901
	120"	393	472	555	636	718	804	888	972	1056	1224	1395	1564	1735	1903	2072
	132"	418	506	594	683	775	865	958	1050	1141	1324	1509	1690	1878	2057	2240
144"	447	541	637	734	832	932	1028	1127	1225	1425	1621	1818	2020	2212	2410	

Manufacturer's suggested retail price

**Notes**

- The 2-on-1 and 3-on-1 headrail option is strongly recommended for the shades measuring 96" or more in width or height.
- Product price only, not including freight, taxes, and other surcharges associated with the custom shade/ requests.
- Prices are applied to the cordless and clutch shades. Please check surcharges for the different operating systems.
- Base prices apply to cordless and clutch shades. Please check the surcharges for the different operating systems.

7/16" – Double Cell Light Filtering (PX3AO)												BASE PRICE GROUP 4				
WIDTH TO:	7"- 24"	30"	36"	42"	48"	54"	60"	66"	72"	84"	96"	108"	120"	132"	144"	
HEIGHT TO:	5" - 36"	194	221	255	287	342	351	385	420	453	521	591	656	725	790	855
	42"	212	244	279	321	350	395	431	472	508	584	663	738	817	890	966
	48"	220	259	298	342	377	420	463	505	550	631	717	800	885	967	1050
	54"	241	280	323	369	412	459	505	551	597	686	780	871	966	1051	1143
	60"	263	305	354	399	447	501	549	603	652	753	853	953	1054	1135	1252
	66"	283	331	382	433	486	544	598	653	708	819	927	1036	1147	1255	1364
	72"	300	348	405	460	517	578	634	693	754	868	988	1105	1219	1336	1447
	78"	321	379	439	501	564	627	690	755	820	946	1075	1200	1331	1456	1582
	84"	336	400	463	531	595	664	731	802	868	1003	1138	1274	1414	1546	1680
	90"	353	420	490	559	630	704	775	850	923	1066	1211	1354	1501	1644	1788
	96"	369	441	511	587	663	738	816	893	969	1122	1278	1428	1583	1732	1884
	108"	402	477	558	641	725	810	891	978	1063	1230	1394	1563	1734	1897	2067
	120"	439	523	617	709	802	895	988	1083	1175	1359	1549	1734	1922	2106	2292
	132"	474	572	673	774	876	979	1084	1185	1289	1495	1701	1905	2113	2310	2517
144"	502	609	718	826	936	1048	1157	1267	1383	1602	1818	2038	2263	2479	2698	

Manufacturer's suggested retail price

Prices

3/4" – Single Cell Blackout Smooth (PS44C) 9/16" – Single Cell Light Filtering Fire Retardant (PS310FR)												BASE PRICE GROUP 5				
WIDTH TO:	7"- 24"	30"	36"	42"	48"	54"	60"	66"	72"	84"	96"	108"	120"	132"	144"	
HEIGHT TO:	5" - 36"	209	239	272	305	335	373	408	444	480	552	628	700	774	844	916
	42"	228	260	297	336	372	417	453	493	534	618	700	780	865	945	1073
	48"	246	285	328	372	412	460	504	553	598	693	788	879	977	1069	1161
	54"	270	310	357	408	453	505	555	607	656	761	865	967	1073	1173	1277
	60"	296	333	385	441	489	546	597	658	714	826	939	1048	1164	1278	1387
	66"	313	357	413	471	526	588	644	707	767	888	1012	1134	1257	1373	1497
	72"	334	385	448	511	571	639	700	770	834	967	1105	1237	1371	1502	1636
	78"	355	407	474	542	609	679	748	822	889	1032	1175	1317	1463	1602	1746
	84"	371	428	501	574	642	718	789	869	941	1095	1246	1395	1552	1703	1855
	90"	392	457	534	609	686	767	843	928	1007	1171	1332	1497	1663	1826	1992
	96"	406	477	558	640	719	805	887	975	1060	1230	1405	1577	1753	1927	2101
	108"	441	519	611	703	793	888	976	1075	1168	1357	1551	1740	1936	2128	2321
	120"	474	565	664	764	867	966	1067	1174	1276	1483	1692	1906	2118	2330	2598
	132"	514	613	725	836	970	1059	1170	1284	1398	1626	1858	2087	2325	2629	2996
144"	548	657	775	896	1053	1142	1261	1382	1506	1752	2002	2251	2553	2918	3333	

Manufacturer's suggested retail price

Notes

- The 2-on-1 and 3-on-1 headrail option is strongly recommended for the shades measuring 96" or more in width or height.
- Product price only, not including freight, taxes, and other surcharges associated with the custom shade/ requests.
- Base prices apply to cordless and clutch shades. Please check the surcharges for the different operating systems.

3/4" – Single Cell Blackout Linen Print (PS441)												BASE PRICE				6
9/16" – Single Cell Blackout (PS320)												GROUP				
WIDTH TO:	7"- 24"	30"	36"	42"	48"	54"	60"	66"	72"	84"	96"	108"	120"	132"	144"	
HEIGHT TO:	5" - 36"	226	260	296	331	365	406	443	482	522	600	682	761	842	917	996
	42"	249	282	323	366	405	453	492	535	580	671	762	848	941	1027	1167
	48"	268	310	357	405	448	501	547	601	651	752	856	956	1062	1161	1261
	54"	293	337	388	443	493	548	603	661	714	826	941	1051	1167	1275	1389
	60"	322	362	419	479	531	594	650	715	775	898	1021	1139	1265	1389	1507
	66"	341	387	449	511	571	639	700	768	834	965	1099	1233	1366	1493	1627
	72"	364	418	488	555	621	694	762	837	907	1052	1200	1344	1490	1634	1777
	78"	386	442	516	589	663	738	813	892	966	1121	1278	1432	1590	1740	1897
	84"	403	465	545	624	697	781	858	945	1023	1191	1355	1517	1687	1851	2017
	90"	426	496	580	663	745	834	916	1008	1095	1273	1449	1627	1808	1984	2166
	96"	442	518	607	696	782	876	964	1060	1152	1337	1528	1714	1906	2095	2284
	108"	480	565	664	764	862	964	1061	1168	1270	1476	1685	1892	2104	2313	2523
	120"	516	614	723	830	964	1051	1159	1276	1387	1612	1840	2072	2302	2532	2824
	132"	559	666	787	909	1054	1150	1272	1396	1519	1767	2020	2269	2527	2859	3256
144"	596	715	843	973	1145	1241	1371	1502	1637	1904	2175	2448	2775	3171	3624	

Manufacturer's suggested retail price

Prices

3/4" – Single Cell Blackout (PS420)												BASE PRICE				7
3/4" – Single Cell Blackout Bamboo Print (PS42RA)												GROUP				
3/4" – Single Cell Blackout Tweed Print (PS423)																
1-1/4" – Single Cell Blackout (PS620) *																
WIDTH TO:	7"- 24"	30"	36"	42"	48"	54"	60"	66"	72"	84"	96"	108"	120"	132"	144"	
HEIGHT TO:	5" - 36"	250	286	325	365	402	447	488	531	574	660	751	837	927	1009	1095
	42"	273	310	355	402	445	497	541	589	639	738	838	933	1035	1130	1283
	48"	294	341	392	445	493	552	603	661	715	827	942	1051	1168	1277	1388
	54"	322	372	427	488	542	603	663	727	785	910	1035	1156	1283	1403	1528
	60"	354	398	460	527	584	653	714	787	853	987	1123	1254	1392	1528	1659
	66"	375	426	494	563	629	702	769	846	917	1062	1209	1356	1503	1642	1790
	72"	400	460	537	611	682	763	838	921	997	1157	1320	1479	1639	1797	1955
	78"	424	487	567	648	729	813	893	982	1062	1234	1405	1575	1749	1914	2086
	84"	444	511	600	687	767	860	944	1039	1126	1309	1491	1668	1856	2037	2218
	90"	469	546	639	729	820	917	1008	1109	1204	1401	1593	1789	1989	2183	2381
	96"	486	570	668	766	861	963	1060	1166	1267	1471	1681	1885	2097	2305	2513
	108"	528	621	730	840	949	1061	1167	1285	1397	1624	1854	2082	2315	2544	2775
	120"	567	675	795	913	1060	1156	1275	1404	1526	1774	2024	2279	2532	2786	3106
	132"	615	732	866	999	1159	1265	1400	1536	1672	1945	2221	2496	2780	3144	3582
144"	655	786	927	1071	1259	1365	1509	1653	1801	2095	2393	2692	3052	3488	3986	

Manufacturer's suggested retail price

Notes

- The 2-on-1 and 3-on-1 headrail option is strongly recommended for the shades measuring 96" or more in width or height.
- Product price only, not including freight, taxes, and other surcharges associated with the custom shade/ requests.
- Base prices apply to cordless and clutch shades. Please check the surcharges for the different operating systems.
- The cellular shade with the 1-1/4" fabric is made with the 3/4" headrail and 3/4" bottom rail.

3/4" – Cell-In-A Cell Light Filtering (PU41SS)												BASE PRICE GROUP				8
3/4" – Single Cell Light Filtering Whisper Woven (PS47KO)																
3/4" – Single Cell Light Filtering Sheer (PS460)																
WIDTH TO:	7" - 24"	30"	36"	42"	48"	54"	60"	66"	72"	84"	96"	108"	120"	132"	144"	
HEIGHT TO:	5" - 36"	277	318	363	413	456	510	556	603	655	759	858	955	1059	1159	1255
	42"	298	346	397	454	501	560	618	671	725	840	952	1061	1174	1288	1395
	48"	317	372	427	488	540	608	665	728	790	913	1037	1159	1287	1410	1531
	54"	347	406	470	532	592	664	729	804	868	1003	1137	1273	1414	1546	1681
	60"	375	437	510	576	639	720	790	866	939	1085	1233	1381	1527	1675	1822
	66"	403	471	545	619	691	774	849	932	1009	1168	1330	1484	1650	1804	1963
	72"	427	500	581	662	738	827	912	999	1082	1251	1427	1592	1766	1934	2106
	78"	450	531	614	698	790	878	973	1063	1156	1335	1518	1698	1882	2065	2245
	84"	469	555	649	738	831	924	1021	1118	1211	1401	1599	1787	1989	2178	2373
	90"	491	584	681	776	873	977	1075	1179	1284	1485	1689	1893	2099	2302	2506
	96"	511	609	709	811	913	1021	1129	1236	1342	1555	1773	1984	2204	2415	2631
	108"	556	662	774	886	1000	1120	1237	1355	1475	1708	1946	2177	2421	2653	2889
	120"	597	717	842	966	1092	1222	1348	1478	1604	1860	2120	2375	2637	2893	3148
	132"	636	769	901	1038	1178	1317	1456	1594	1734	2013	2293	2568	2854	3459	3940
144"	679	823	967	1114	1264	1416	1564	1713	1863	2164	2464	2763	3358	3837	4385	

Manufacturer's suggested retail price

3/4" – Single Cell Light Filtering LUX Linen (PS47BO)												BASE PRICE GROUP				9
3/4" – Single Cell Light Filtering Slub Woven (PS47S)																
9/16" – Single Cell Light Filtering Slub Woven (PS37S)																
9/16" – Single Cell Blackout Fire Retardant (PS320FR)																
WIDTH TO:	7" - 24"	30"	36"	42"	48"	54"	60"	66"	72"	84"	96"	108"	120"	132"	144"	
HEIGHT TO:	5" - 36"	304	349	399	453	501	559	611	662	718	833	941	1048	1162	1272	1377
	42"	328	379	436	499	550	615	677	736	795	921	1045	1164	1288	1413	1531
	48"	347	408	469	534	591	667	730	799	866	1002	1137	1272	1413	1548	1680
	54"	382	446	516	584	651	729	801	881	952	1100	1248	1398	1552	1698	1845
	60"	411	480	559	631	700	790	866	951	1030	1191	1352	1515	1674	1838	1999
	66"	442	516	598	678	759	850	932	1022	1108	1282	1459	1629	1811	1980	2155
	72"	469	548	638	727	810	909	1002	1096	1187	1372	1566	1747	1938	2121	2312
	78"	493	582	674	766	866	964	1068	1167	1268	1465	1665	1862	2065	2266	2463
	84"	514	609	711	810	912	1014	1121	1227	1329	1537	1753	1960	2182	2390	2604
	90"	539	641	747	851	957	1072	1180	1294	1410	1629	1852	2077	2304	2526	2750
	96"	562	669	778	889	1002	1121	1239	1356	1473	1708	1946	2176	2418	2650	2887
	108"	611	727	850	972	1098	1229	1357	1486	1618	1874	2134	2389	2656	2911	3171
	120"	654	787	924	1060	1198	1341	1479	1623	1759	2041	2326	2605	2894	3173	3454
	132"	698	844	989	1138	1293	1444	1599	1750	1902	2208	2517	2818	3132	3520	4100
144"	745	902	1062	1223	1387	1553	1716	1879	2044	2375	2704	3031	3420	3984	4552	

Manufacturer's suggested retail price

Notes

- The 2-on-1 and 3-on-1 headrail option is strongly recommended for the shades measuring 96" or more in width or height.
- Product price only, not including freight, taxes, and other surcharges associated with the custom shade/ requests.
- Base prices apply to cordless and clutch shades. Please check the surcharges for the different operating systems.

3/4" – Cell-In-A Cell Blackout (PS42SS)												BASE PRICE GROUP <b>10</b>			
WIDTH TO:	7"- 24"	30"	36"	42"	48"	54"	60"	66"	72"	84"	96"	108"	120"	132"	144"
5" - 36"	350	401	458	522	576	643	703	762	826	957	1081	1206	1336	1463	1584
42"	378	436	501	574	633	707	779	847	913	1060	1202	1338	1480	1626	1760
48"	399	469	539	615	680	767	839	919	996	1152	1308	1463	1625	1780	1932
54"	439	513	594	672	748	838	921	1014	1095	1265	1436	1607	1785	1952	2121
60"	472	552	642	726	805	909	996	1093	1185	1370	1555	1742	1926	2113	2299
66"	508	594	687	780	873	977	1072	1175	1274	1474	1678	1873	2083	2277	2478
72"	540	630	733	836	932	1045	1152	1260	1365	1578	1801	2009	2228	2440	2659
78"	567	670	775	881	996	1108	1228	1342	1459	1684	1915	2141	2375	2607	2833
84"	591	700	818	931	1048	1165	1290	1411	1528	1768	2017	2255	2510	2749	2994
90"	619	737	859	979	1101	1233	1356	1488	1621	1874	2130	2388	2649	2905	3162
96"	646	769	895	1023	1152	1290	1424	1560	1693	1965	2238	2503	2781	3048	3321
108"	703	836	977	1117	1263	1413	1561	1710	1860	2155	2455	2748	3054	3348	3646
120"	752	906	1062	1219	1378	1542	1700	1866	2023	2347	2675	2996	3328	3649	3973
132"	803	970	1137	1309	1486	1661	1838	2012	2187	2539	2894	3241	3601	3943	4294
144"	857	1038	1221	1407	1595	1786	1973	2160	2350	2731	3109	3486	3873	4242	4623

Manufacturer's suggested retail price

Prices

**Notes**

- The 2-on-1 and 3-on-1 headrail option is strongly recommended for the shades measuring 96" or more in width or height.
- Product price only, not including freight, taxes, and other surcharges associated with the custom shade/ requests.
- Base prices apply to cordless and clutch shades. Please check the surcharges for the different operating systems.

# Surcharges, Size Limitations, and Features

Surcharges	Add to the cordless shade price (MSRP)
Premium Cordless	No additional surcharge
Premium Cordless Top Down Bottom Up	\$80.00 per shade
Clutch	No additional surcharge
Clutch Top Down Bottom Up	\$80.00 per shade
Non-moveable arch, quarter arch, and circle	10%
Moveable octagon	50%
Slider - Left Stack & Right Stack	See page 17-18
Slider - Center Split	See page 17-18

Surcharges	Details (MSRP)
Skylight	\$90.00 per shade
Day/Night Shade- two fabrics on the top and bottom	The price is calculated by combining two shades.
Tile cut out (no warranty for cut out)	\$63.00 per side
2-on-1 & 3-on-1 headrail	The shades are priced individually
Top Light Blocker (white only)	\$8/ per ft. The top light blocker, one piece per shade, will be cut to the shade ordered width. No deduction.
Side Light Blocker (white only)	\$10/ per ft. The side light blockers, two pieces per shade, will be cut to the shade order height. No deduction.
Upgrade the 9/16" or 7/16" shade with a 3/4" headrail*	\$24.00 per shade
Aluminum skylight pole	\$75.00 for the length 3 ft - 5.5 ft \$100.00 for the length 3.5 ft - 9 ft

Surcharges  
Size limitations

Notes: The 3-on-1 headrail is not available for the clutch control.

\* The option to upgrade the 9/16" or 7/16" shade with a 3/4" headrail is available for all operation systems except the Simple Touch® Wand, skylight, arch, quarter arch, circles, and octagons.

Size limitations by shade type	Cordless	Cordless TDBU	Cordless Day/Night	Clutch	Clutch TDBU	Clutch Day/Night	Skylight	Slider
Minimum Width	12"	19"	19"	12"	23"	23"	16"	24"
Minimum Height	10"	10"	10"	10"	10"	10"	10"	24"
Maximum Width	96"	96"	72"	120"	120"	72"	60"	120"
Maximum Height	96"	84"	72"	120"	120"	72"	60"	118"

Note: Custom cordless shades with drop between 84" and 96" are manufactured with flat modules.

- Standard Features:**
- A 1/4" deduction will be taken for the inside mount.
  - Aluminum headrail and bottom rail

- Day/Night Shade**
- Aluminum headrail, middle rail, and bottom rail

- Features:**
- The headrail color coordinates with the fabric color at the top; the middle and bottom rail colors coordinate with the fabric color at the bottom.
  - The light filtering fabric is on the top and the blackout fabric is on the bottom.
  - Standard clutch control is right clutch operates bottom rail, left clutch operates middle rail. The reverse control is available and upon request.

- Skylight Shade**
- The finished size **must** be provided. **No deductions will be taken by the manufacturer.**

- Features:**
- Color coordinated headrails, middle rails, bottom rails and fabrics for the motorized skylight.
  - For the cordless skylight, the headrail and bottom rail colors coordinate with fabric colors while supplies last. After running out of inventory, the manufacturer will use the white headrail and bottom rail only. The middle rail color always coordinates with the fabric color.
  - The side rail color of both cordless and motorized skylights come only in white #001.
  - The skylight shade is available for all HT fabrics except 1-1/4" and Cell-In-A Cell fabrics.
  - All skylight shades are only made with 9/16" headrails.

Match your decor with  
a slider cellular shade

# SLIDER CELLULAR SHADES



Insulation  
Noise Reduction  
Energy Efficiency  
Cordless Design For Child Safety

## Features

- A vertical cellular shade to match other cellular shades in the home
- Ideal for the patio doors, wide windows, and room dividers
- The finished shades are available in **Left Stack**, **Right Stack**, and **Center Split**
- Aluminum headrail, side rails, handle, headrail mounting brackets and end caps are available in 3 colors, including vanilla #593 (off-white), transparent aluminum #091, and black #025.
- Integrated headrail. No valance needed.
- Cordless design to give peace of mind to parents.
- Handle location is about the middle of the moving rail.
- Fabric selections are available in 3/4", 9/16", and 1-1/4" cellular fabrics except linen print, sheer, and 7/16" double cell.

## Prices

	Add to the regular cordless shade price	Equal to Multiplier
Left Stack and Right Stack	100%	2
Center Split	120%	2.2

## Size Limitations

Minimum Width	Minimum Height	Maximum Width	Maximum Height
24"	24"	120"	118"

## Stack Width

	Left Stack	Right Stack	Center Split
Minimum Width	6"	6"	6" on each side

## Deductions

	Width	Height
Inside Mount	1/4"	1/2"
Outside Mount	No deductions	

## Minimum Mounting Space

	Minimum Mounting Depth	Minimum Flush Mount Depth
Inside Mount	2-3/4"	4"
	<b>Minimum Flat Vertical Surface</b>	
Outside Mount	2-1/4"	



Cordless design



Insulating Energy saving \$



Easy installation

Fabric options include most of the cellular fabrics\* in both light filtering and blackout selections.

Systems available in Left Stack, Right Stack, and Center Split

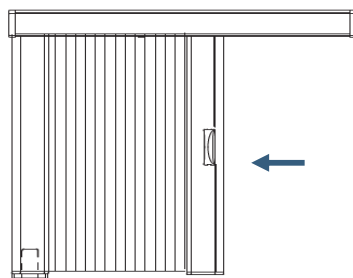

Left Stack

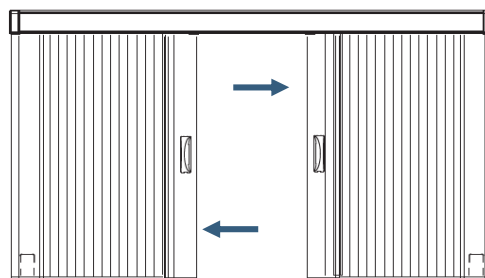

Center Split

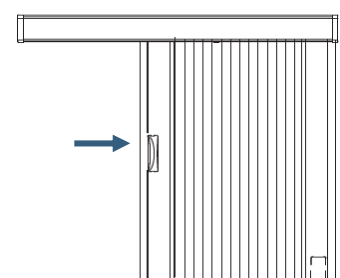

Right Stack

## NOTES

- The stationary rail bottom bracket (floor bracket) can be mounted to the floor or the side walls. The extension bracket is available upon request.
- To mount the stationary rail bottom bracket (floor bracket) to the floor, the distance between the floor and the bottom of the shade can not be bigger than 1-1/2".
- The following fabrics are not available for slider cellular shades:
  - Linen print, sheer, and 7/16" double cell.



## Vertical Cellular Shades

<b>9/16" - Single Cell Light Filtering (PS310)</b> <b>3/4" - Single Cell Smooth Light Filtering (PS43C)</b> <b>3/4" - Single Cell Light Filtering (PS410)</b> <b>3/4" - Single Cell Bamboo Light Filtering (PS41RA)</b> <b>3/4" - Single Cell Tweed Print Light Filtering (PS413)</b> <b>1 1/4" - Single Cell Light Filtering (PS610)</b>															
<b>GROUP 1</b>															
WIDTH TO:	7" - 24"	30"	36"	42"	48"	54"	60"	66"	72"	84"	96"	108"	120"	132"	144"
<b>36"</b>	319	351	384	416	445	468	502	531	559	615	670	773	815	857	897
<b>42"</b>	328	361	397	431	458	489	523	554	584	643	695	809	857	903	945
<b>48"</b>	334	374	410	443	475	508	542	578	607	672	737	846	893	947	995
<b>54"</b>	342	382	420	458	491	525	561	599	632	701	771	882	915	993	1042
<b>60"</b>	349	391	433	470	508	544	582	620	657	731	804	918	977	1035	1092
<b>66"</b>	359	401	445	485	525	563	605	643	683	758	836	953	1019	1082	1142
<b>72"</b>	368	412	458	502	542	580	622	664	706	788	869	993	1056	1126	1191
<b>78"</b>	374	420	468	512	559	601	643	689	731	815	903	1033	1098	1172	1239
<b>84"</b>	382	431	479	525	573	620	667	712	756	842	935	1069	1142	1220	1289
<b>90"</b>	389	439	491	540	592	636	687	733	781	869	970	1105	1184	1262	1338
<b>96"</b>	395	452	502	557	607	655	706	756	804	901	1004	1142	1224	1308	1388
<b>108"</b>	405	462	519	571	626	678	733	785	836	937	1044	1189	1277	1365	1451
<b>120"</b>	420	483	544	601	659	716	773	827	882	993	1109	1260	1355	1453	1544

Manufacturer's suggested retail price

<b>9/16" - Single Cell Blackout (PS320)</b> <b>3/4" - Single Cell Smooth Blackout (PS44C)</b> <b>3/4" - Single Cell Blackout (PS420)</b> <b>3/4" - Single Cell Bamboo Blackout (PS42RA)</b> <b>3/4" - Single Cell Tweed Print Blackout (PA423)</b> <b>1 1/4" - Single Cell Blackout (PS620)</b>															
<b>GROUP 2</b>															
WIDTH TO:	7" - 24"	30"	36"	42"	48"	54"	60"	66"	72"	84"	96"	108"	120"	132"	144"
<b>36"</b>	370	410	449	487	523	557	594	632	667	737	872	945	998	1058	1113
<b>42"</b>	382	420	466	508	546	582	624	664	704	779	918	995	1061	1126	1184
<b>48"</b>	393	437	483	527	567	609	653	697	737	821	962	1050	1115	1189	1254
<b>54"</b>	405	452	502	548	592	634	683	729	773	861	1012	1100	1172	1262	1323
<b>60"</b>	416	466	529	567	613	662	712	760	809	903	1056	1155	1235	1317	1394
<b>66"</b>	428	481	536	586	638	689	741	794	844	943	1105	1208	1296	1382	1464
<b>72"</b>	439	494	552	609	664	716	773	825	880	987	1153	1264	1352	1447	1539
<b>78"</b>	447	508	569	628	687	743	800	861	918	1029	1199	1319	1413	1512	1611
<b>84"</b>	458	521	586	647	710	771	832	890	949	1067	1247	1373	1476	1579	1678
<b>90"</b>	470	536	603	668	735	796	861	924	987	1107	1298	1426	1533	1642	1743
<b>96"</b>	481	552	620	687	758	825	890	958	1023	1149	1344	1481	1594	1709	1823
<b>108"</b>	494	567	643	712	788	857	928	998	1065	1203	1399	1546	1667	1791	1913
<b>120"</b>	517	599	676	754	834	909	985	1061	1134	1283	1443	1649	1781	1917	2077

Manufacturer's suggested retail price

## Vertical Cellular Shades

**9/16" - Single Cell Slub Woven (PS47S)**  
**3/4" - Single Cell Slub Woven (PS37S)**  
**3/4" - Single Cell Whisper Woven (PS47KO)**  
**3/4" - Single Cell Lux LInen (PS47BO)**

**GROUP 3**

WIDTH TO:	7" - 24"	30"	36"	42"	48"	54"	60"	66"	72"	84"	96"	108"	120"	132"	144"
<b>36"</b>	458	508	558	604	648	690	736	784	826	914	1080	1172	1236	1312	1380
<b>42"</b>	474	520	578	630	676	720	774	822	872	966	1138	1234	1314	1396	1468
<b>48"</b>	486	542	598	654	702	754	810	864	914	1018	1192	1302	1382	1474	1554
<b>54"</b>	502	560	622	680	734	786	846	904	958	1068	1254	1364	1452	1564	1640
<b>60"</b>	516	578	642	702	760	820	882	942	1002	1120	1310	1432	1530	1632	1728
<b>66"</b>	530	596	664	726	792	854	918	984	1046	1168	1370	1496	1606	1712	1814
<b>72"</b>	544	612	684	754	822	888	958	1022	1090	1224	1428	1566	1676	1794	1908
<b>78"</b>	554	630	706	778	852	922	992	1068	1138	1276	1486	1634	1752	1874	1996
<b>84"</b>	568	646	726	802	880	956	1030	1104	1176	1322	1546	1702	1830	1958	2080
<b>90"</b>	584	664	748	828	912	986	1068	1146	1224	1372	1608	1768	1900	2036	2160
<b>96"</b>	596	684	768	852	940	1022	1104	1186	1268	1424	1667	1836	1976	2118	2260
<b>108"</b>	512	702	796	882	976	1062	1150	1236	1320	1492	1734	1916	2066	2220	2372
<b>120"</b>	640	742	838	934	1034	1128	1220	1314	1406	1590	1788	2044	2208	2376	2574

Manufacturer's suggested retail price

# The Cellular Shade Collection

Cellular shade collection

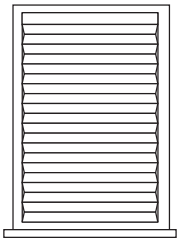

Cordless

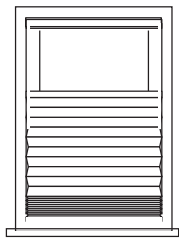

Cordless  
Top Down Bottom Up

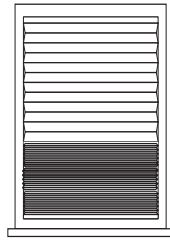

Cordless Day/Night

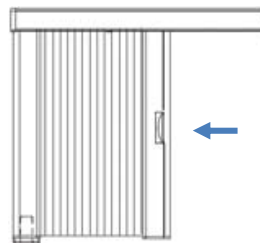

Slider - Side Stack

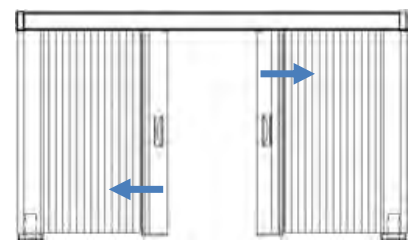

Slider - Center Split

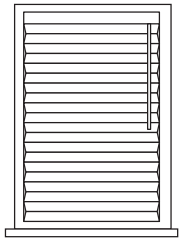

Clutch

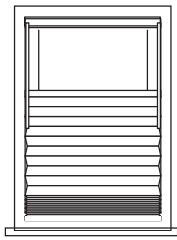

Clutch  
Top Down Bottom Up

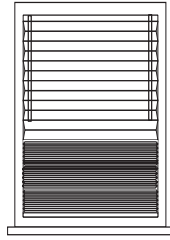

Clutch Day/Night

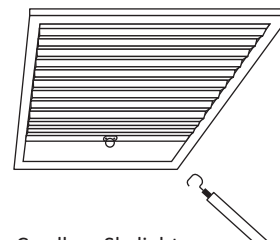

Cordless Skylight

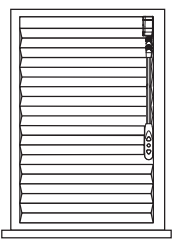

Simple Touch®  
Wand

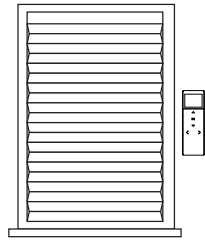

Simple Touch®  
Remote

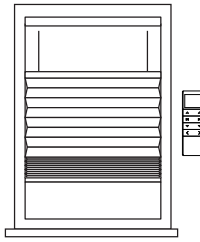

Simple Touch®  
Top Down  
Bottom Up

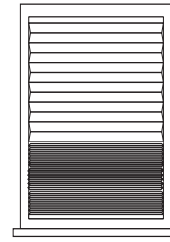

Simple Touch®  
Day/ Night

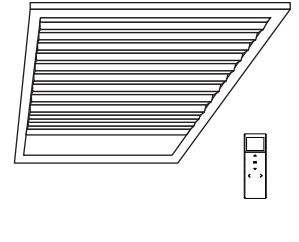

Motorized Skylight

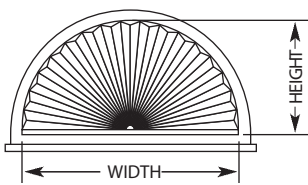

Standard Arch

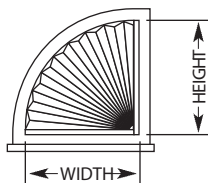

Half Arch

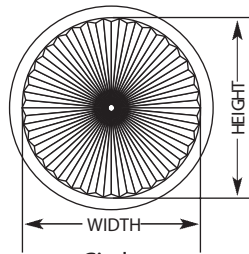

Circle

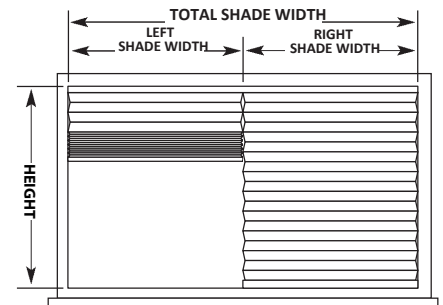

2-on-1 Headrail

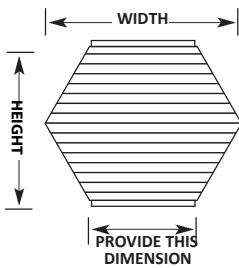

Hexagon

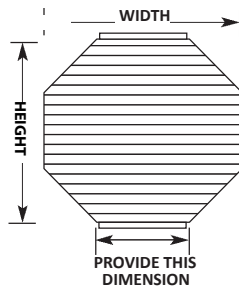

Octagon

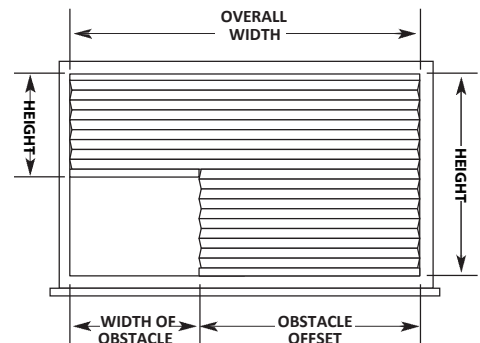

Cutout

## ARCHES

Width      MINIMUM = 18"                      MAXIMUM = 84"  
 Height     MINIMUM = 9"                        MAXIMUM = 48"  
 Non-movable arches  
 Non-perfect arches require templates

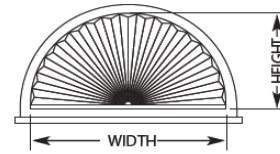

Standard Arch

### Perfect Arches (Do not require a template)

- The Perfect Arches are those where the radius of the circle is consistent at all points.

### Non-perfect Arches (A Template is required.)

- The Non-perfect Arches are not consistent at all points. Deviation of even 1/16" makes it imperfect.

## QUARTER ARCHES

Width      MINIMUM = 9"                        MAXIMUM = 50"  
 Non-movable quarter arches  
 Non-perfect quarter arches require templates.

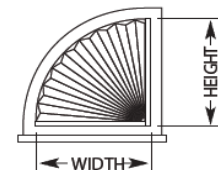

Half Arch

## CIRCLES

Width      MIN 9/16" = 9"                        MAX 9/16" = 42"  
 Width      MIN 7/16" = 12"                      MAX 7/16" = 42"  
 Non-movable circles  
 Non-perfect circles require templates.

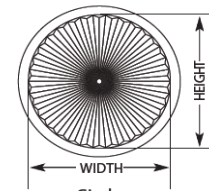

Circle

## OCTAGONS

Width      MINIMUM = 21"                        MAXIMUM = 48"  
 Height     MINIMUM = 12"                        MAXIMUM = 48"  
 Measurement of all 8 sides are needed.  
 Templates are required.

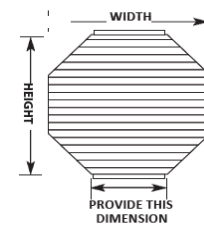

Octagon

## HEXAGON

Width      MINIMUM = 21"                        MAXIMUM = 48"  
 Height     MINIMUM = 12"                        MAXIMUM = 48"  
 Measurement of all 6 sides are needed.  
 Templates are required.

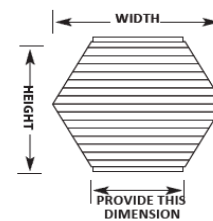

Hexagon

- For the arch and quarter arch cellular shades, the rail colors coordinate with fabric colors while supplies last. After running out of inventory, the manufacturer will use the white #001 rail only.
- Specialty cellular shades are not available for the skylights.

# MOTORIZED CELLULAR SHADES



## 3 BRANDS AVAILABLE

- SIMPLE TOUCH
- ROLLEASE AUTOMATE
- SOMFY

# Simple Touch® Wand Custom Cellular Shades

**Simple Touch® Wand** motorized cellular shades are powered by the Simple Touch® rechargeable battery pack. The motor can support a shade up to 9 lbs. This unique cordless, battery powered shade has a control on a wand handle. Consumers do not have to worry about losing their remote control.

**Simple Touch® Wand** cellular shades are constructed with a heavy duty 9/16" headrail and a variety of cellular fabrics. **The manufacturer will program the top and bottom limits for each shade.**

Surcharge	Added to the cordless price (MSRP)
Simple Touch® Wand	\$ 380

Power Source: Simple Touch® rechargeable battery pack (included)

SIMPLE TOUCH® WAND SIZE LIMITATION	
Minimum Width	24"
Minimum Height	12"
Maximum Width	120"
Maximum sq. ft. for the Single Cell	96 sq.ft.
Maximum sq. ft. for the Double Cell	75 sq.ft.
Maximum sq. ft. for the Cell-In-A Cell	64 sq.ft.

## FEATURES OF THE WAND

- Standard length: half of the drop of the shade
  - The wand is clear with the white cord inside
  - Minimum wand length: 12"
  - Maximum wand length: 60"
- \*NOTE:** Standard wand control is on the right side unless specified.

## Simple Touch® Wand Motorized Cellular Shades

- The Simple Touch® wand is available with all WWC fabrics.
- The headrail is only made with 9/16" headrail.
- Color coordinated headrail, end caps, and wand handle
- Pre-programmed with the top and bottom limits
- Option to follow the programming instruction to set up my favorite position
- No hand remote control
- Powered by a Simple Touch® rechargeable battery pack (included)

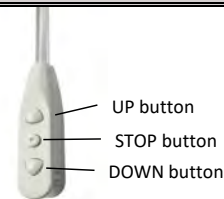

## Power Sources and Solar Panel

- **Standard power source - Simple Touch® rechargeable battery pack**
  - The minimum flush mounting space is 3-1/4" when hooking the battery pack behind the headrail.
  - Option to mount it to the wall or window frame. Keep it away from the sunlight.
  - The mounting brackets and screws are included.
  - The USB wall adaptor and 80" USB-C charge cord are included. **The default quantity of the charger and USB cord is 1 set per order.** You can request more sets at no cost, up to the same quantity as the rechargeable battery pack you ordered.
  - Color - White
  - Indoor use only
- **Optional solar panel - requires a rechargeable battery pack**
  - The Simple Touch® rechargeable battery pack is compatible with a solar panel from Rollease.
  - The installation kit and USB cord are included.
- **Optional power source - Power adaptor**
  - Powered the shade directly from the wall plug.



ADDITIONAL HARDWARE	MSRP
Simple Touch® rechargeable battery pack	\$ 140
USB wall adaptor (for recharging the rechargeable battery pack)	\$ 30
Solar panel (from Rollease Acmeda)	\$ 320
Power extension cord (118")	\$ 30
Power adaptor (with 70" cord)	\$ 60

NOTE. It's not recommend for using a 3rd party USB charger block.

## COLOR COORDINATION

- Simple Touch® Wand cellular shade follows the standard color coordination chart.
- Color coordinated headrail, bottom rail, and end caps

## UPPER LIMIT, LOWER LIMIT, MY FAVORITE POSITION, AND PROGRAMMING GUIDE

Simple Touch® Wand cellular shade is preset with upper position at 0", and lower position at ordered drop.

My favorite position feature is available, simply follow the programming guide inside the package to set it up. The instruction is also available on [www.westernwc.info](http://www.westernwc.info).

## INSTALLATION

Simple Touch® Wand cellular shade is installed with heavy duty brackets. The installation instruction is included in the hardware bag and also available on the WWC Website [www.westernwc.info](http://www.westernwc.info)

# Simple Touch® 15-Channel Remote Custom Cellular Shades

The **Simple Touch® Remote** motorized shade is operated by a low voltage (12V) motor and powered by a rechargeable battery pack. The shade is operated by a 15-channel remote. The motor lifts a motorized shade up to 9 lbs. **Simple Touch®** is an exclusive brand of WWC and is an economical option. The motorized control systems include regular, top down bottom up, Day/Night, and skylight. The **Simple Touch®** remote cellular shades are made with a heavy duty headrail and the finest cellular fabric. In the motorized shade, top and bottom limits will be set up before shipping. In addition, the shade also features a favorite position. Programming instructions and a user guide are available in the package and also on the WWC website at [www.westernwc.info](http://www.westernwc.info).

Simple Touch® Shades	Surcharge MSRP (added to the cordless price)
Regular	\$ 540
Top Down Bottom Up	\$ 620
Day/Night	\$ 620
Skylight	\$ 700

Power Source: Simple Touch® rechargeable battery pack (included)

Remote controls and hub		Prices (MSRP)
Remote controls	Regular	\$ 130
	Top Down Bottom Up	\$ 170
	Day/Night	\$ 170
	Skylight	\$ 130
Hub	P-box	\$ 435

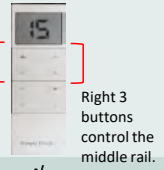
Remote controls	For regular and skylight shades	For TDBU & Day/Night shades
Image		
LED screen	✓	✓
15-channel	✓	✓
My favorite	✓	✓
Group control	✓	✓
Available Color	White	White
Dimensions	1-5/8"W x 5-3/8"H x	1-3/4"W x 5-1/8"H x 1/2"D
* The two remote controls are not interchangeable.		

Simple Touch Remote

## Simple Touch® Motorized Cellular Shade

### Regular

- All WWC fabrics are available.
- The shade is pre-programmed with top and bottom limits. The bottom limit is the ordered drop.
- Controlled by a 15-channel remote.

### Top Down Bottom Up and Day/ Night

- All WWC fabrics are available.
- Controlled by a TDBU 15-channel remote.
- The TDBU remote can control the middle rail and the bottom rail individually or together at the same time.
- The right 3 buttons on the remote are designed to control the middle rail. The left 3 buttons control the bottom rail.

### Skylight

- All WWC fabrics are available except 1-1/4" and 3/4" Cell-In-A Cell fabrics
- The fabric is located between the middle rail and bottom rail. The rail with the motor inside should be always installed at the top.
- The middle rail is pre-programmed with top and bottom limits.
- The headrail and bottom rail are made with 9/16" cordless rail and are non-movable.
- The finished size must be provided. No deductions will be taken by the manufacturer.**
- The side rail is available in 3 colors, including cotton #001, transparent aluminum # 091, and black #025.
- The length of the headrail including end caps is 5/8" less than the finished size.

My favorite position can be set up followed by the programming instruction on the WWC website at [www.westernwc.info](http://www.westernwc.info).

## Power Source, Solar Panel, and Hub

- All Simple Touch® motorized shades are powered by the Simple Touch® rechargeable battery pack (included)
- Compatible with the solar panel (sold separately) from Rollease via a USB cord.
- Using a HUB "Simple Touch® P-BOX", you can control up to 30 smart shades via a smart device from anywhere.
  - Compatible with Apple HomeKit, Amazon Alexa, and Google Home.

**NOTE 1.** The default quantity of the charger and USB cord is 1 set per order. You can request more sets at no cost up to the same quantity as the rechargeable battery pack you ordered.

**NOTE 2.** Install the rechargeable battery pack away from direct sunlight.



ADDITIONAL HARDWARE	Prices (MSRP)
Simple Touch® Rechargeable battery pack	\$ 140
USB wall adaptor	\$ 30
Solar panel (requires a rechargeable battery pack)	\$ 320
Power extension cord (118")	\$ 30
Power adaptor (with 70" cord)	\$ 60

Note - Do not use the 3rd party USB charger block to recharge the rechargeable battery pack.

SIZE LIMITATION		Regular	TDBU & Day/Night	Skylight
Minimum Width		18"	32"	20"
Minimum Height		12"	12"	12"
Maximum Width		120"	120"	60"
Maximum Height		See below		60"
Maximum sq. ft.	Single Cell	96 sq.ft.	96 sq.ft.	25 sq.ft.
	Double Cell	75 sq.ft.	75 sq.ft.	25 sq.ft.
	Cell-In-A Cell	64 sq.ft.	64 sq.ft. (44 sq.ft. for the Day/Night)	N/A

### COLOR COORDINATION

The color coordinated headrail, middle rail, bottom rail, and end caps follow the standard color coordination chart.

### INSTALLATION AND PROGRAMMING

Simple Touch® cellular shade is programmed with the top and bottom limits. The installation instructions and programming guide are included in the hardware bag and also available at [www.westernwc.info](http://www.westernwc.info).



## Simple Touch® P-Box

Work with:

- Simply Motorized Shade
- Simple Touch Regular Motorized Shade
- Simple Touch Top Down Bottom Up Motorized Shade

APP name: Shade Connector+



### Step1. Download APP



### Step2. Create your account



Simple Touch  
Hub

### Step3. Pairing the P-Box to your smart device. Choose one option from the below.



Pairing via ethernet  
for iOS



Pairing via 2.4GHz  
WiFi for iOS



Pairing via ethernet  
for Android



Pairing via 2.4GHz  
WiFi for Android

### Step4. Follow the instructions on the APP to link your shade to the P-Box

1. Click “+” to add a device

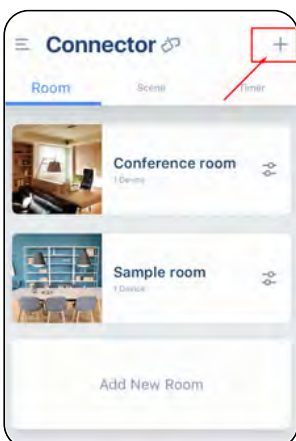

2. Click “Radio Motor”



3. Choose “Honeycomb, TDBU or Day&night” to link your shade to the P-BOX

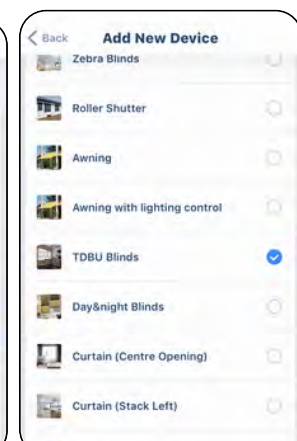
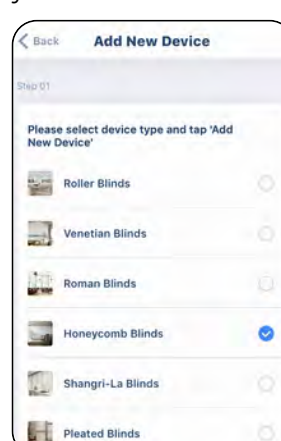



# Rollease Acmeda Motorized Custom Cellular Shades

With this new partnership, WWC and Rollease Acmeda are working together to provide customers with a comprehensive suite of automated window treatments to fit any application. Our Automate™ motorized cellular shade is made with the low voltage motor that is powered by a lithium rechargeable battery pack. Simply plug it to the motor and then enjoy the benefits of a motorized shade! The shade systems include regular motorized shades and skylight.

Automate™ motorization products have been developed to be seamlessly compatible with Apple HomeKit, Amazon Alexa and Google Home. Simply install the Pulse 2 Hub, download the Automate Pulse 2 App – available for iOS and Android, and set up an account to easily control your smart shades with your voice or smart devices anytime and any where.

Rollease (with the rechargeable battery pack, one per motor)	Surcharge MSRP (Added to the cordless price)
<b>Regular</b>	\$ <b>670</b>
<b>Skylight</b>	\$ <b>895</b>

\* See the size limitations on the next page.

Remote controls and hub		Prices (MSRP)
<b>Hand</b>	5-channel	\$ <b>250</b>
<b>Remotes</b>	15-channel	\$ <b>290</b>
<b>Wall</b>	5-Channel Surface Mount Wall Switch (white)	\$ <b>210</b>
<b>Switches</b>	15-Channel Cut-In Wall Switch (white)	\$ <b>250</b>
<b>Hub</b>	Automate Pulse 2 Bridge White/ Platinum	\$ <b>670</b>



**Pulse 2 Hub**  
Allows you to control your shades with a voice command or smart device.



5-channel hand remotes



15-channel hand remotes



5-channel wall switch



15-channel wall switch (cut in)

- **HAND REMOTES** - 5- and 15- channel remotes. Both comes with 2 colors, black and white.
- **WALL SWITCHES** - A wire free deployment
  - 5-channel surface mount wall switch - mount the switch directly to the wall without cut into the wall. It can control up to 5 shades individually or in groups.
  - 15-channel cut-in wall switch - It can control up to 15 individual shades or in a group. It fits the standard size of the single gang wall box.
- **HUB - PULSE II**
  - Control your shades via a smart device or voice command after connected the PULSE II to your automate cellular shade and remote.
  - APP required.

ACCESSORIES	Surcharge (MSRP)
Rollease rechargeable battery pack	\$ <b>250</b>
5V USB wall charger	\$ <b>30</b>
5V USB charge cable - 156"/ 13ft/ 4M	\$ <b>50</b>
Solar panel (requires a rechargeable battery pack)	\$ <b>320</b>
96" DC motor cable extender (connects the motor to the rechargeable battery pack)	\$ <b>25</b>

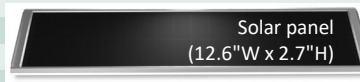

Solar panel  
(12.6"W x 2.7"H)

## Rollease Automate Motorized Cellular Shades

### Regular

- Powered by a lithium rechargeable battery pack or a DC power panel
- Color coordinated headrail and bottom rail
- Controlled by hand remote, wall switch, and/or hub.
- Radio frequency control
- Mounting brackets are included.
- Available for all WWC fabrics
- The flush depth including the headrail and battery pack is 3-1/4".



Automate™ rechargeable battery pack



Charge block & 156" USB cable (1 set/ per order)\*

### Skylight

- Powered by a lithium rechargeable battery pack or a DC power panel
- All WWC fabrics are available except 1-1/4" and 3/4" Cell-In-A Cell fabrics
- Standard location for the fabric on the motorized skylight is between the middle and bottom rails. The rail with the motor inside should be always installed at the top.

- **The finished size must be provided. No deductions will be taken by the manufacturer.**
- The 96" DC motor cable extender (that connects the motor to the battery) is available to order when needed.

**NOTE: Install the rechargeable battery pack away from the direct sunlight.**

**NOTE: The default quantity of the charger and USB cord is 1 set per order. You can request more sets at no cost up to the same quantity as the rechargeable battery pack you ordered.**

# Rollease Acmeda Motorized Custom Cellular Shades

SIZE LIMITATION	REGULAR	SKYLIGHT
Minimum Width	18"	20"
Minimum Height	12"	12"
Maximum Width	120"	60"
Maximum Height	120"	60"



\* When using a different power source, the size limitation of the Rollease motorized shade remains the same.

Besides the rechargeable battery pack, we also offer a DC power distribution panel. It is a great option if you are building or renovating a house. This DC power distribution panel allows all Rollease automated cellular shades to function without recharging. A DC power distribution panel can support up to 18 motors at a time. The AC cord and harnesses are required. Choosing flush mount wall switch (5-channel) remotes and/or cut-in wall switch (15-channel) remotes when ordering the DC power panel is another worthwhile consideration. Include them in your project!

Release (power source: DC power panel)	Surcharge MSRP (Added to the cordless price)
Regular	\$ 475
Skylight	\$ 650

#### What is the best time to order your power panel and hard wire accessories?

- Once the blueprint is finalized
- Know how many windows you will install with cellular shades. Calculate the quantity of DC power panel and accessories you need.
- Inform WWC in advance before ordering the Automate cellular shades.

DC Power Panel and Accessories		Surcharge (MSRP)
DC Power Distribution Panel	 Capacity for up to 18 DC motors. Works for different wire types. The keys, screws, and fuses are included. Dimensions: 9.27"W x 12.65"H x 2.6"D	\$ 700
AC Cord (for the DC power panel)	 Require one AC cord per DC power panel Length: 6ft	\$ 50
DC Connection Harness	 Require one harness per motor Length: 3"	\$ 20

#### Motor Power Distribution Setup Diagram

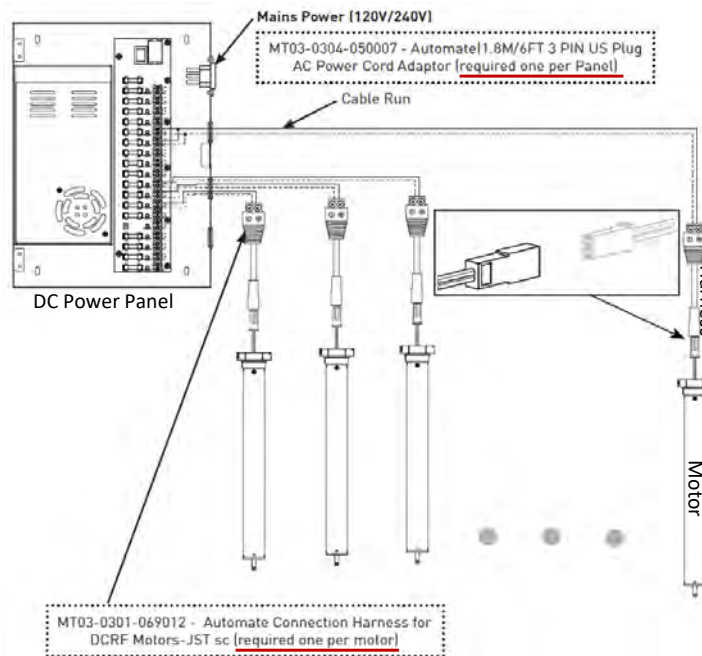

**Note:** The hard wire installation is only to be performed by a suitably qualified installer. Detailed instructions for routing the cable and connecting the motors to DC power are available on the WWC website.

#### Color Matching:

To ensure color matching, all cellular shades must be ordered at the same time. This will eliminate possible variations due to the fabric nature. Product availability is subject to change without notice.

Have a question about Automate programming or Pulse 2 app? Rollease technical support team can help you. Call Rollease technical support at (203) 590-5318 Monday through Friday from 8:30am to 5pm Eastern Standard Time or email your questions to [ustechsupport@rolleaseacmeda.com](mailto:ustechsupport@rolleaseacmeda.com).

Programming and installation videos are available at the WWC website [www.westernwc.info](http://www.westernwc.info).

# Motorized Custom Cellular Shades & Tahoma

WWC also offers the Somfy motorized shade that is operated by a battery powered motor TL25 and with the Radio Technology Somfy (RTS) system. The shade is powered by a Somfy lithium rechargeable battery pack. The solar panel is available as well. Control your shades via a hand remote or a hub "Tahoma". Both feature group control function. With Somfy solutions, everything becomes easy!

Somfy motorized cellular shade	Surcharge MSRP (added to the cordless price)
Regular	\$ 890
Skylight	\$ 1,065

Remote controls and hub		Surcharge (MSRP)
Hand Remotes	Situo RTS 1-channel	\$ 230
	Situo RTS 1-channel	\$ 315
	Telis RTS 16-channel	\$ 800
Hub	Tahoma	\$ 850

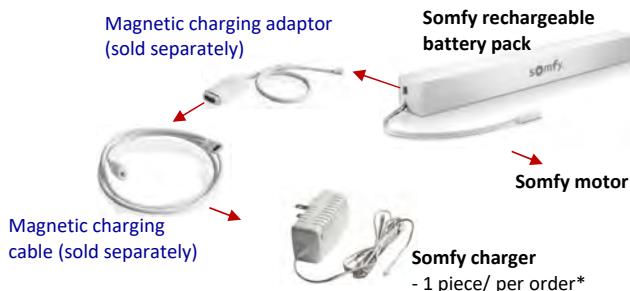

**Hand Held Remote Control (3 options):**

- Option 1: A single channel RTS remote controls one individual or one group Somfy motorized cellular shades.
- Option 2: A 5-channel RTS remote controls up to five individual or five groups of the Somfy motorized shades.
- Option 3: A 16-channel RTS remote controls up to 16 individual or 16 groups of the Somfy motorized shades.

## Somfy Motorized Cellular Shades

### Regular

- All WWC fabrics are available.
- The li-ion rechargeable battery pack, mounting clips, and charger are included\*
- The flush mount depth including the headrail and battery pack is 3-1/4".
- Controlled by the remote you choose. Sold separately.
- Convert it to a smart shade via the hub "Tahoma". Sold separately.
- The shade is pre-programmed with top and bottom limits. The bottom limit is the ordered drop.



Somfy

### Skylight

- All WWC fabrics are available except 1-1/4" and 3/4" Cell-In-A Cell fabrics
- The fabric is located between the middle rail and bottom rail. The rail with the motor inside should be always installed at the top.
- The middle rail is pre-programmed with top and bottom limits.
- The headrail and bottom rail are made with 9/16" cordless rail and are non-movable.
- The length of the headrail including end caps is 5/8" less than the finished size.
- The side rail is available in 3 colors, including cotton #001, transparent aluminum # 091, and black #025.
- The finished size must be provided. No deductions will be taken by the manufacturer.**

- NOTES:**
- The default quantity of the Somfy charger is 1 piece per order. You can request more chargers at no cost up to the same quantity as the rechargeable battery pack you ordered.
  - Please read the Somfy Rechargeable Battery Pack Instruction carefully before installing and before using the battery. The hard copy is inside the battery pack box.
  - Do not install the battery where it will be exposed to direct sun light.**

## Power Source, Solar Panel, and Hub

- All Somfy motorized shades are powered by the Somfy lithium rechargeable battery pack.
- The Somfy solar panel is available and sold separately.
- The hub **Tahoma** is a WIFI to RTS gateway that can control up to 40 RTS channels. Tahoma integrates with third-party systems, including Google Assistant and Amazon Alexa, allowing natural voice commands for controlling shades. In addition, you can easily customize scenes and schedules to fit your lifestyle. Tahoma is easy to install and use, and it's perfect for operating all Somfy-HT motorized cellular shades in your entire house.

Accessories	Surcharge	Size Limitations	Regular	Skylight
Somfy Rechargeable battery pack	\$ 175	Minimum Width	20"	20"
Wall charger for the rechargeable battery pack (80"-cord)	\$ 60	Minimum Height	12"	12"
94.5" extension cable (from wall charger to the battery pack)	\$ 25	Maximum Width	120"	60"
Magnetic charging adaptor - 8"L	\$ 45	Maximum Height	120"	60"
Rigid magnetic charging cable - 33"L	\$ 60			
Solar panel (requires a rechargeable battery pack)	\$ 330			



**Color Matching:**

To ensure color matching, all cellular shades must be ordered at the same time. This will eliminate the possible variations due to the nature of the fabric. Product availability is subject to change without notice.

Have a question about Somfy programming or myLink app? Somfy tech team can help you. Call Somfy at **(800) 227-6639** Monday through Friday from 8am to 8pm Eastern Standard Time or email to [technicalSupport\\_us@somfy.com](mailto:technicalSupport_us@somfy.com).

# SIMPLY CORDLESS

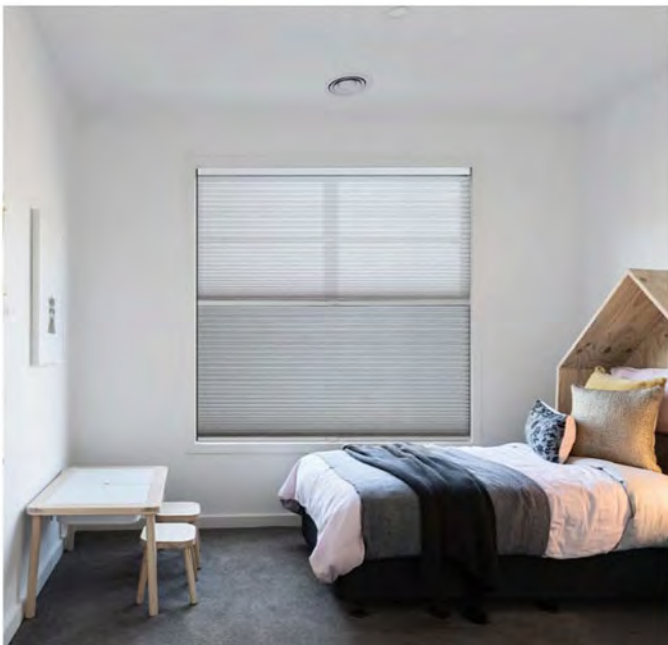

Single Cell Light Filtering			
48-INCH DROP		72-INCH DROP	
WIDTH	PRICE EACH	WIDTH	PRICE EACH
30"	\$ 53	30"	\$ 60
38"	\$ 64	38"	\$ 72
54"	\$ 84	54"	\$ 94
72"	\$ 117	72"	\$ 128

Single Cell Blackout			
48-INCH DROP		72-INCH DROP	
WIDTH	PRICE EACH	WIDTH	PRICE EACH
30"	\$ 78	30"	\$ 86
38"	\$ 97	38"	\$ 110
54"	\$ 130	54"	\$ 147
72"	\$ 175	72"	\$ 201

Manufacturer's Suggested Retail Price

### FEATURE:

- Available in 10 solid colors and 2 bamboo print colors for both light filtering and blackout cellular shades.
- State-of-the-Art vinyl headrail and bottom rail system
- Easy to install with hidden brackets
- Label width is the actual width of the shade, no deduction
- 100% polyester spun lace non-woven fabric
- 6Pcs / master case



9/16" Single Cell Light Filtering		9/16" Single Cell Blackout	
Item #	Color	Item #	Color
1G001	Cotton	2G001	Cotton
1G070	Winter White	2G070	Winter White
1G006	Fawn	2G006	Fawn
1G346	Antique Pewter	2G346	Antique Pewter
1G030	Anthracite	2G030	Anthracite
1G069	White Dove	2G069	White Dove
1G021	Gray Sheen	2G021	Gray Sheen
1G514	Misty Gray	2G514	Misty Gray
1G492	Warm Cocoa	2G492	Warm Cocoa
1G519	Sticks & Stones	2G519	Sticks & Stones
7G519	Bamboo Print Stone	8G519	Bamboo Print Stone
7G344	Bamboo Print Pebble	8G344	Bamboo Print Pebble

Surcharge MSRP	Details
Cut Width	\$13/ per shade

### NOTES

1. The cut down width has 1/4" deduction for the inside mount.
2. Will Not Shorten the Height.

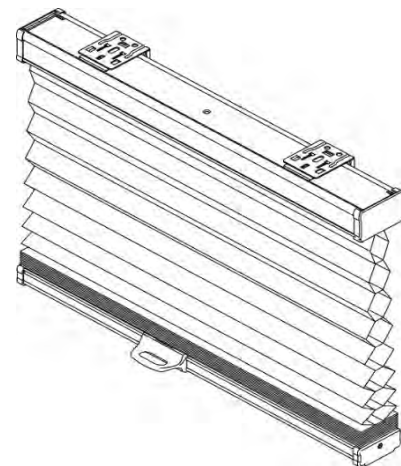

TRIM ALLOWANCES		Minimum Width
Shade Width	MAXIMUM CUT	
30"	6" from each side for a total of 12"	18"
38"	4" from each side for a total of 8"	30"
54"	8" from each side for a total of 16"	38"
72"	9" from each side for a total of 18"	54"

# Simply Cordless® Top Down Bottom Up Cellular Shade

Single Cell Light Filtering			
48-INCH DROP		72-INCH DROP	
WIDTH	PRICE EACH	WIDTH	PRICE EACH
30"	\$74	30"	\$82
38"	\$85	38"	\$93
54"	\$114	54"	\$125
72"	\$160	72"	\$173

Single Cell Blackout			
48-INCH DROP		72-INCH DROP	
WIDTH	PRICE EACH	WIDTH	PRICE EACH
30"	\$100	30"	\$108
38"	\$124	38"	\$140
54"	\$159	54"	\$178
72"	\$216	72"	\$243

Manufacturer's Suggested Retail Price

## FEATURE:

- Available in 10 solid colors and 2 bamboo print colors for both light filtering and blackout cellular shades.
- State-of-the-Art Vinyl headrail, middle rail, and bottom rail system.
- Easy to install with hidden brackets
- Label width is the actual width of the shade, no deduction
- 100% polyester spun lace non-woven fabric
- 6Pcs / master case



Simply Cordless  
Top Down Bottom Up

9/16" Single Cell Light Filtering		9/16" Single Cell Blackout	
Item #	Color	Item #	Color
1T001	Cotton	2T001	Cotton
1T070	Winter White	2T070	Winter White
1T006	Fawn	2T006	Fawn
1T346	Antique Pewter	2T346	Antique Pewter
1T030	Anthracite	2T030	Anthracite
1T069	White Dove	2T069	White Dove
1T021	Gray Sheen	2T021	Gray Sheen
1T514	Misty Gray	2T514	Misty Gray
1T492	Warm Cocoa	2T492	Warm Cocoa
1T519	Sticks & Stones	2T519	Sticks & Stones
7T519	Bamboo Print Stone	8T519	Bamboo Print Stone
7T344	Bamboo Print Pebble	8T344	Bamboo Print Pebble

Surcharge MSRP	Details
Cut Width	\$13/ per shade

## NOTES

1. The cut down width has 1/4" deduction for the inside mount.
2. Will Not Shorten the Height.

TRIM ALLOWANCES		Minimum Width
Shade Width	MAXIMUM CUT	
30"	3.5" from each side for a total of 7"	23"
38"	4" from each side for a total of 8"	30"
54"	8" from each side for a total of 16"	38"
72"	9" from each side for a total of 18"	54"

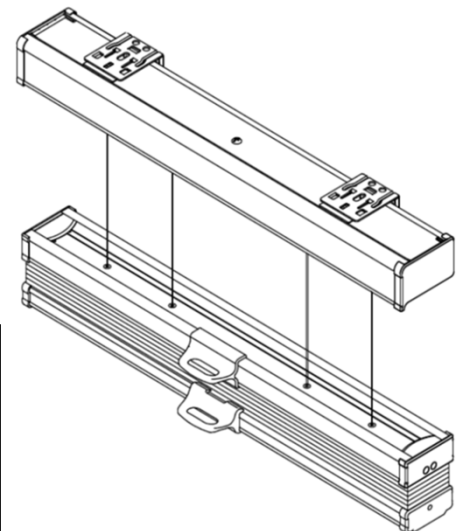

Single Cell Day/Night			
48-INCH DROP		72-INCH DROP	
WIDTH	PRICE EACH	WIDTH	PRICE EACH
30"	\$ 114	30"	\$ 135
38"	\$ 143	38"	\$ 168
54"	\$ 190	54"	\$ 227
72"	\$ 263	72"	\$ 305

Manufacturer's Suggested Retail Price

## FEATURE:

- Available in 10 solid colors
- Single cell light filtering fabric on the top and blackout fabric on the bottom
- State-of-the-Art Vinyl headrail, middle rail, and bottom rail system.
- Easy to install with hidden brackets
- Label width is the actual width of the shade, no deduction
- 100% polyester spun lace non-woven fabric
- 6Pcs / master case



Simply Cordless  
Day/Night

9/16" Single Cell Day/Night			
Item #	Color	Item #	Color
1D001	Cotton	1D069	White Dove
1D070	Winter White	1D021	Gray Sheen
1D006	Fawn	1D514	Misty Gray
1D346	Antique Pewter	1D492	Warm Cocoa
1D030	Anthracite	1D519	Sticks & Stones

Surcharge MSRP	Details
Cut Width	\$13/ per shade

## NOTES

1. The cut down width has 1/4" deduction for the inside mount.
2. Will Not Shorten the Height.

TRIM ALLOWANCES		Minimum Width
Shade Width	MAXIMUM CUT	
30"	3.5" from each side for a total of 7"	23"
38"	4" from each side for a total of 8"	30"
54"	8" from each side for a total of 16"	38"
72"	9" from each side for a total of 18"	54"

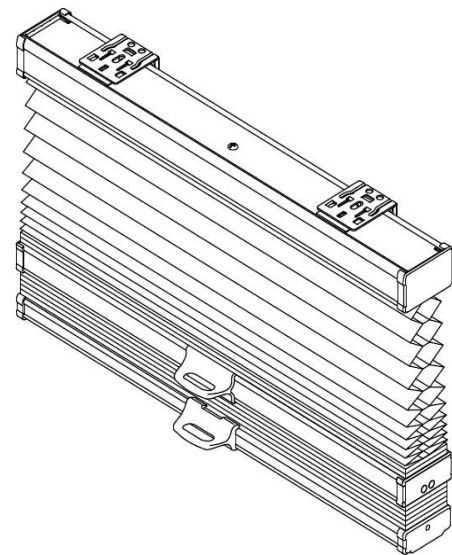

# Simply Cordless® Motorized Cellular Shade

Simply Cordless  
Motorization

Single Cell Light Filtering			
48-INCH DROP		72-INCH DROP	
WIDTH	PRICE EACH	WIDTH	PRICE EACH
38"	\$ 244	38"	\$ 252
54"	\$ 264	54"	\$ 274
72"	\$ 297	72"	\$ 308

Single Cell Blackout			
48-INCH DROP		72-INCH DROP	
WIDTH	PRICE EACH	WIDTH	PRICE EACH
38"	\$ 277	38"	\$ 290
54"	\$ 310	54"	\$ 327
72"	\$ 355	72"	\$ 381

Manufacturer's Suggested Retail Price

## FEATURE:

- Available in 3 colors for light filtering and blackout.
- Each motorized shade comes with a single channel remote with 2 AAA alkaline batteries and a battery box with 8 AA lithium batteries.
- The single channel remote is connected to the shade with default top and bottom limits. "My favorite position" is also available. See the programming guide inside the package or on the WWC website.
- When necessary, you can adjust the shade height by resetting the bottom limit.
- The battery box can be hooked behind the headrail or installed on the wall or window frame.
- Upgrade to the rechargeable battery pack with additional charge is available.
- The 15-channel remote is available. Sold separately.
- Easy to install with hidden brackets
- Label width is the actual width of the shade, no deduction.
- Indoor use only.
- 100% polyester spun lace non-woven fabric
- 6Pcs / master case

9/16" Single Cell Light Filtering		9/16" Single Cell Blackout	
Item #	Color	Item #	Color
1M001	Cotton	2M001	Cotton
1M069	White Dove	2M069	White Dove
1M021	Gray Sheen	2M021	Gray Sheen

Surcharge	MSRP
Cut Down Fee	\$13/ per shade
Reprogramming	\$21/ per shade

## NOTES

1. The cut down width has 1/4" deduction for the inside mount.
2. Will Not Shorten the Height.

Optional Accessories	Surcharge MSRP
8 AA Lithium batteries	\$ 45
1-Channel Remote	\$ 50

- The Simple Touch rechargeable battery pack, USB wall adaptor, 15-channel remote, and hub are also available. Check the Simple Touch section for product information and prices.

TRIM ALLOWANCES		
Shade Width	Maximum Cut	Minimum Width
38"	9" from each side for a total of 18"	20"
54"	13" from each side for a total of 26"	28"
72"	13" from each side for a total of 26"	46"

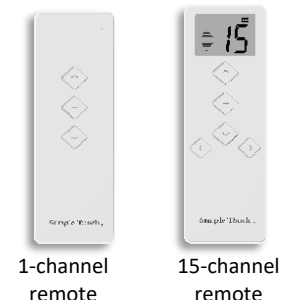
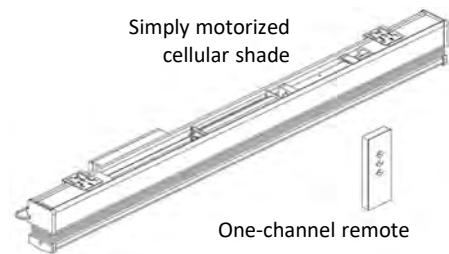



# How to Measure Your Windows

Measure each window individually as sizes may vary. Measure the window width first, then height (length) to the nearest 1/8". Using a metal tap measure the window width from the left to the right and the window height from the top to the bottom. **PLEASE DO NOT USE A CLOTH TAPE!**

## Inside Mount:

Inside mount shades are installed inside the window frame.

1. Measure the exact inside width of the window frame from one inside edge to the other. Take three measurements - one near the top, one in the center, and one near the bottom. Record the narrowest measurement.
2. Measure the exact height in three places: left, center and right from top edge of opening to top of sill. Record the longest measurement for the cellular shade.
3. Do not take deductions on inside mount measurements. The factory will take an 1/4" allowances for operating clearance.
4. Measure the window diagonally in two places as shown. If the two diagonal measurements are not the same, we suggest an outside mount application for the best shade performance and appearance.

## Outside Mount:

Outside mount shades are installed outside the window frame, covering an area larger than the window itself.

1. Measure the exact width of the area to be covered. Be certain the measurement overlaps the window opening by at least 1-1/2" on each side to ensure privacy and light control.
2. Measure exact height to be covered, including desired overlap (usually from top edge of molding to bottom edge, or to top of sill). If there is no sill, measure to where the shade is to reach.
3. The factory does not make deductions for an outside mount.

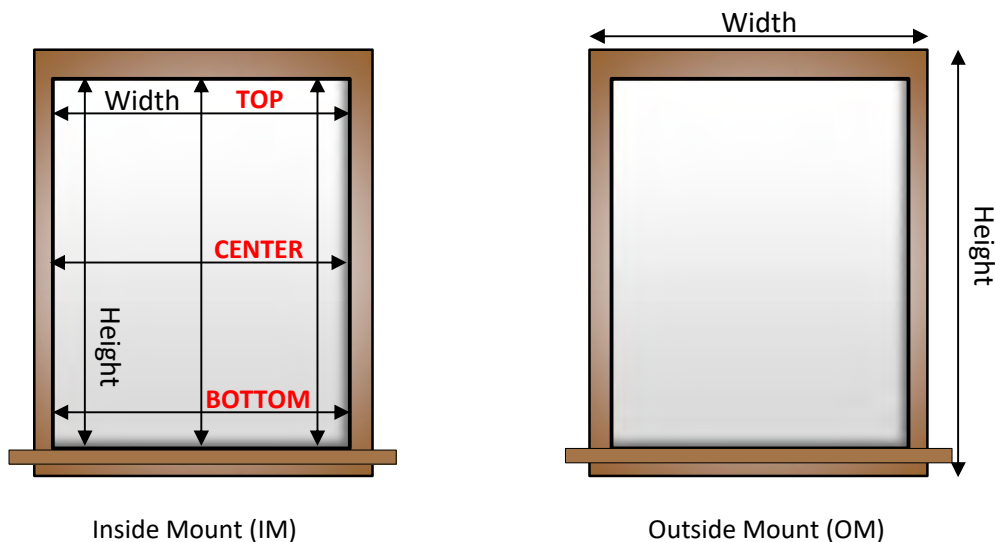

For more questions about how to measure your window, please contact us at 605-999-2267.

## LIMITED LIFETIME MANUFACTURER WARRANTY

### WHAT IS COVERED BY THE WARRANTY

- Warranty is offered to the original owner.
- The warranty only applies to products installed properly in the window for where they were intended, following Western Window Coverings installation instructions, care guide, programming instructions, and suggestions.
- WWC's warranty applies to products made and assembled solely with WWCs original materials.
- Warranty will repair or replace the product solely at WWC's option due to defective material or poor workmanship.
- This warranty gives you specific legal rights and you may also have other rights, which vary from the state to state.

**Note: The motorized parts is 5-year warranty.**

### WHAT IS NOT COVERED BY THE WARRANTY

- This warranty does not apply to any WWC products damaged by accident, misuse, abuse, direct exposure to salty air or improper moisture, discoloration due to sunlight, under exposure or irregular temperature.
- This warranty does not apply to conditions caused by normal wear and tear upon the product. It does not apply to any product damaged by fire, flood, wind, rain, lightning, or other act of nature environment.
- In no event shall WWC be liable for incidental or consequential damage, loss, cost, expense or fee.
- Warranty does not apply to liquidated or discontinued items.
- Warranty does not include shipping charges.

### ABOUT THE SHIPPING AND RETURN FEES

- **Within 12 months**

WWC pays for return on the repairs within 12 months of receipt of the products. WWC will ship the products back to the customer for free.

- **After 12 months**

The customers are responsible for the return shipping. WWC will cover the repair cost and ship it back for free.

### HOW TO OBTAIN WARRANTY SERVICE

Please contact Western Window Coverings, Inc. with the following information, including:

- Original sales receipt
- Model and identification numbers
- Detail description of defect