

2024

# Sheerview Shadings



Western Window Coverings, Inc.

(605) 999-2267 / [www.westernwc.info](http://www.westernwc.info) / [orders.westernwc@gmail.com](mailto:orders.westernwc@gmail.com)

◆ WWC ◆

*Western Window Coverings, Inc.*

# TABLE OF CONTENTS

SHEERVIEW SHADINGS FEATURES	1
AVAILABLE COLORS	2-4
CHILD SAFETY INFORMATION	5
BRACKETS, HEADRAIL AND BOTTOM RAIL INFORMATION	6
PRODUCT DIAGRAMS	7-9
MOTORIZED WAND AND REMOTE PRICING	10
PRICING GRIDS - MSRP	11-17
MEASURING	18-19
PRODUCT OPERATION	20
PROGRAMMING INFORMATION	21
IMPORTANT ORDERING INFORMATION	22
MANUFACTURER'S TERMS AND CONDITIONS	23
WARRANTY	24

# SHEERVIEW SHADINGS FEATURES



- A shade of unique beauty and performance for the finishing touch to your window and room.
- Horizontal fabric vanes float between two layers of soft, knitted sheers to enlighten your view.
- New vane fabrics feature a softer look for your windows.
- Available in widths up to 108" (Woven Fabric) and 116" (Non-Woven Fabric), and drops to lengths of 144" to lend elegance to the widest of windows.
- Vanes glide from open to closed to out-of-sight with graceful, efficient hardware.
- The SHEERVIEW SHADINGS control system provides distinct variations of vane positions for any combination of privacy, view and light control.
- An adjustable weight system hidden in the bottom rail allows for on-the-spot adjustment to lend a balanced appearance in the window.
- Color coordinated, fabric wrapped headrail styles offer a sophisticated look.
- All Inside Mounted (IB) Shades will have a light gap on the left and right side. The side with the controls will have a slightly larger light gap.
- Easy to install hardware and brackets allow for effortless setup and easy removal for cleaning.
- SHEERVIEW SHADINGS can be ultrasonically or traditionally cleaned to stay bright and beautiful.

# AVAILABLE COLORS PRINTED AND SOLID TONES

50mm = 2" Vanes | 65mm = 2.5" Vanes | 70mm = 3" Vanes

D = Room Darkening Vane - Color suffix  
KN = Woven Sheer Vane (★)

## PRINTED TONES



HEATHER  
S65BN311



BLOSSOM  
S65BN206



BLUSH  
S65BN312



BEIGE  
S65BN322



WATERFALL  
S65BN627



GRANITE  
S65BN823

## SOLID TONES



BRIGHT WHITE  
S50PN100 / S70PN100  
S50PN100D / S70PN100D



ALABASTER  
S50PN112 / S70PN112



WINTER WHITE  
S50KN113\* / S70KN113\*  
S50PN113 / S70PN113



LUNA  
S70PN126



BEIGE  
S50KN322\* / S70KN322\*  
S50PN322 / S70PN322  
S50PN322D / S70PN322D



BLOSSOM  
S50KN206\* / S70KN206\*  
S50PN206 / S70PN206

# AVAILABLE COLORS SOLID TONES

50mm = 2" Vanes | 65mm = 2.5" Vanes | 70mm = 3" Vanes

D = Room Darkening Vane - Color suffix  
KN = Woven Sheer Vane (★)

## SOLID TONES

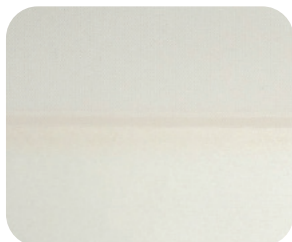

ROMANCE  
S70PN323



LINEN  
S50KN125\* / S70KN125\*  
S50PN125D / S70PN125D



COASTAL PLAIN  
S70PN503



CELADON  
S70PN517



SESAME  
S50PN302 / S70PN302



PLANK  
S70PN371



JAVA  
S50KN378\* / S70KN378\*  
S50PN378 / S70PN378  
S70PN378D



BRICK  
S70PN334D



GRANITE  
S50KN823\* / S70KN823\*  
S50PN823 / S70PN823  
S50PN823D / S70PN823D



RHINestone  
S70PN824

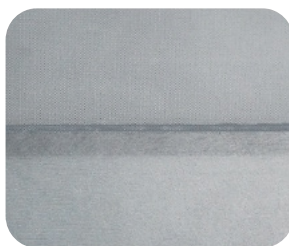

DUSTY BLUE  
S70PN821



ROYAL BLUE  
S70PN029D

# AVAILABLE COLORS SOLID TONES

50mm = 2" Vanes | 65mm = 2.5" Vanes | 70mm = 3" Vanes

D = Room Darkening Vane - Color suffix  
KN = Woven Sheer Vane (★)

## SOLID TONES



EGGSHELL  
S70PN111D



GREEK VILLA  
S70PN114D



BARCELONA BEIGE  
S70PN312D



NATURAL TAN  
S70PN321D



KHAKI  
S70PN303D



BISCUIT  
S50PN145D / S70PN145D



CORNSILK  
S50PN414D / S70PN414D



LAZY GRAY  
S70PN822D



MIDNIGHT  
S70PN016D

# CHILD SAFETY INFORMATION

## THE MANUFACTURER IS COMMITTED TO CHILD SAFETY REGARDING WINDOW COVERINGS

The Manufacturer has committed to join the Window Covering Manufacturers Association's new safety standards in the efforts to prevent accidents involving children and pets with accessible cords and by offering other product options that are child-safe custom window coverings.

## "BEST FOR KIDS" CERTIFIED PROGRAM

Window Covering Manufacturers Association (WCMA) announced the industry's first third-party certification program designed to help consumers and retailers identify window covering products that are best suited for use in homes with young children.

To be part of the new Best for Kids program, products are submitted to a WCMA-recognized third party testing laboratory where the products are required to meet stringent criteria. Once the products meet these criteria, they are Certified Best For Kids. The Manufacturer has a number of products with this distinction.



## CHILD SAFETY IS SERIOUS BUSINESS

That's why the Manufacturer is removing all cords from products, in compliance with the Consumer Product Safety Commission's new guidelines for child-safe window treatments. A variety of control options, including the Safety Wand, traditional cordless control, and motorization, are available, providing the same convenience while making safety a top priority.

For more information on the CPSC's new guidelines and the Manufacturer's compliance with them, please visit: [lantexusa.com](http://lantexusa.com) or [federalregister.gov/documents/2022/11/28/2022-25041/safety-standard-for-operating-cords-on-custom-window-coverings](https://www.federalregister.gov/documents/2022/11/28/2022-25041/safety-standard-for-operating-cords-on-custom-window-coverings).

## OUR SOLUTION

The new Safe Wand control system, introduced in compliance with the CPSC's new guidelines for child safety, offers superior safety without compromising on convenience.

Hold ↑ button and slide along wand to raise shade  
or  
Hold ↓ button and slide along wand to lower shade

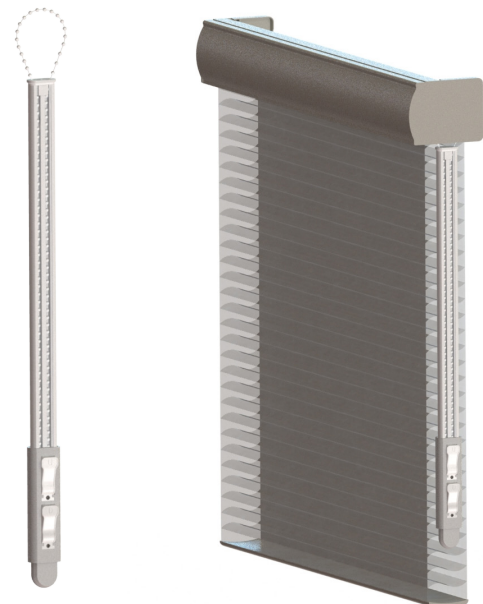

# BRACKETS, HEADRAIL AND BOTTOM RAIL INFORMATION

## BRACKETS

Easy to install One Clip Brackets, come with shims to even the shade if the window jamb is uneven.



## STOPPERS

Prevents the bottom-rail from looping up into the headrail when raised up, or with motorization.



### CURVED HEADRAIL

(standard option)

Matching fabric wrapped comes standard

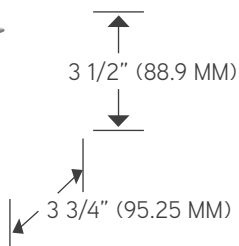

### FLAT HEADRAIL

(upgrade option)

Metal or matching fabric wrapped

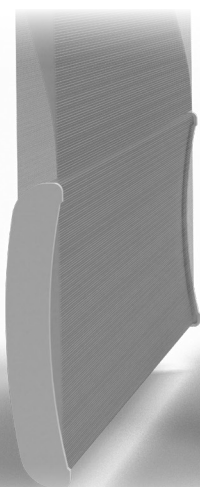
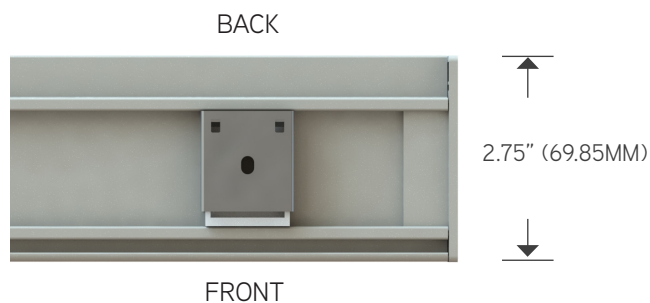
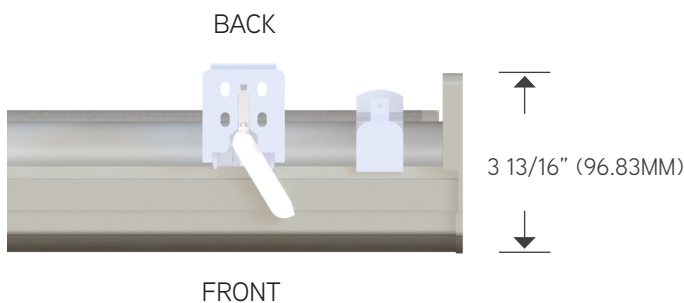
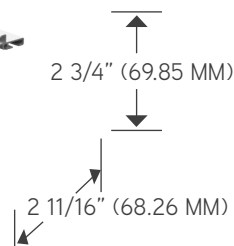

## BOTTOM-RAIL

PATENT PENDING

Bottom-Rail features a superior design that reduces light gap when the SHEERVIEW SHADINGS is in the lowered/closed position.

Adjustable counter weight keeps sheer shade level



# CONTINUOUS CORD OR SAFE WAND SHEERVIEW SHADINGS

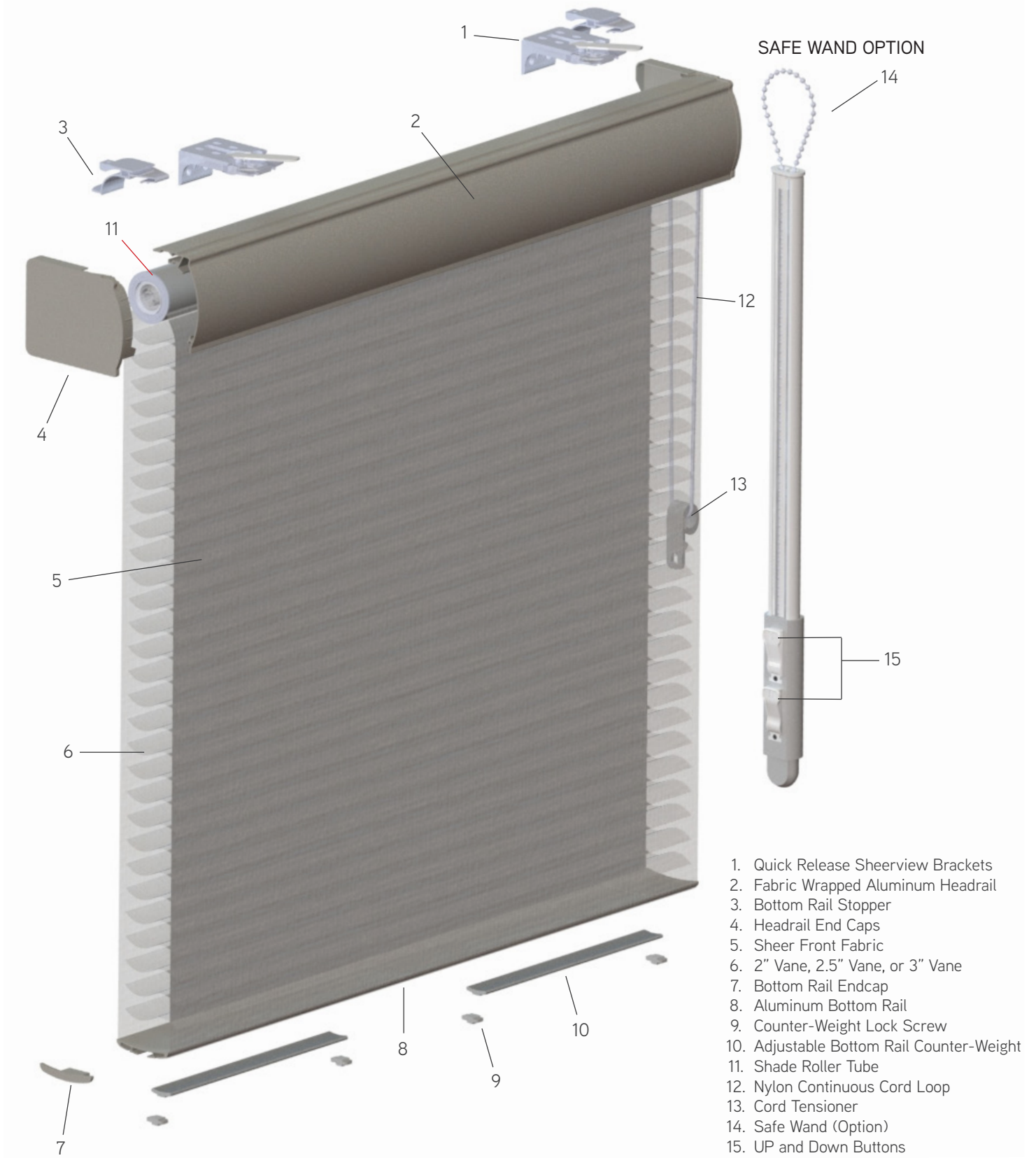

1. Quick Release Sheerview Brackets
2. Fabric Wrapped Aluminum Headrail
3. Bottom Rail Stopper
4. Headrail End Caps
5. Sheer Front Fabric
6. 2" Vane, 2.5" Vane, or 3" Vane
7. Bottom Rail Endcap
8. Aluminum Bottom Rail
9. Counter-Weight Lock Screw
10. Adjustable Bottom Rail Counter-Weight
11. Shade Roller Tube
12. Nylon Continuous Cord Loop
13. Cord Tensioner
14. Safe Wand (Option)
15. UP and Down Buttons

# CORDLESS SHEERVIEW SHADINGS

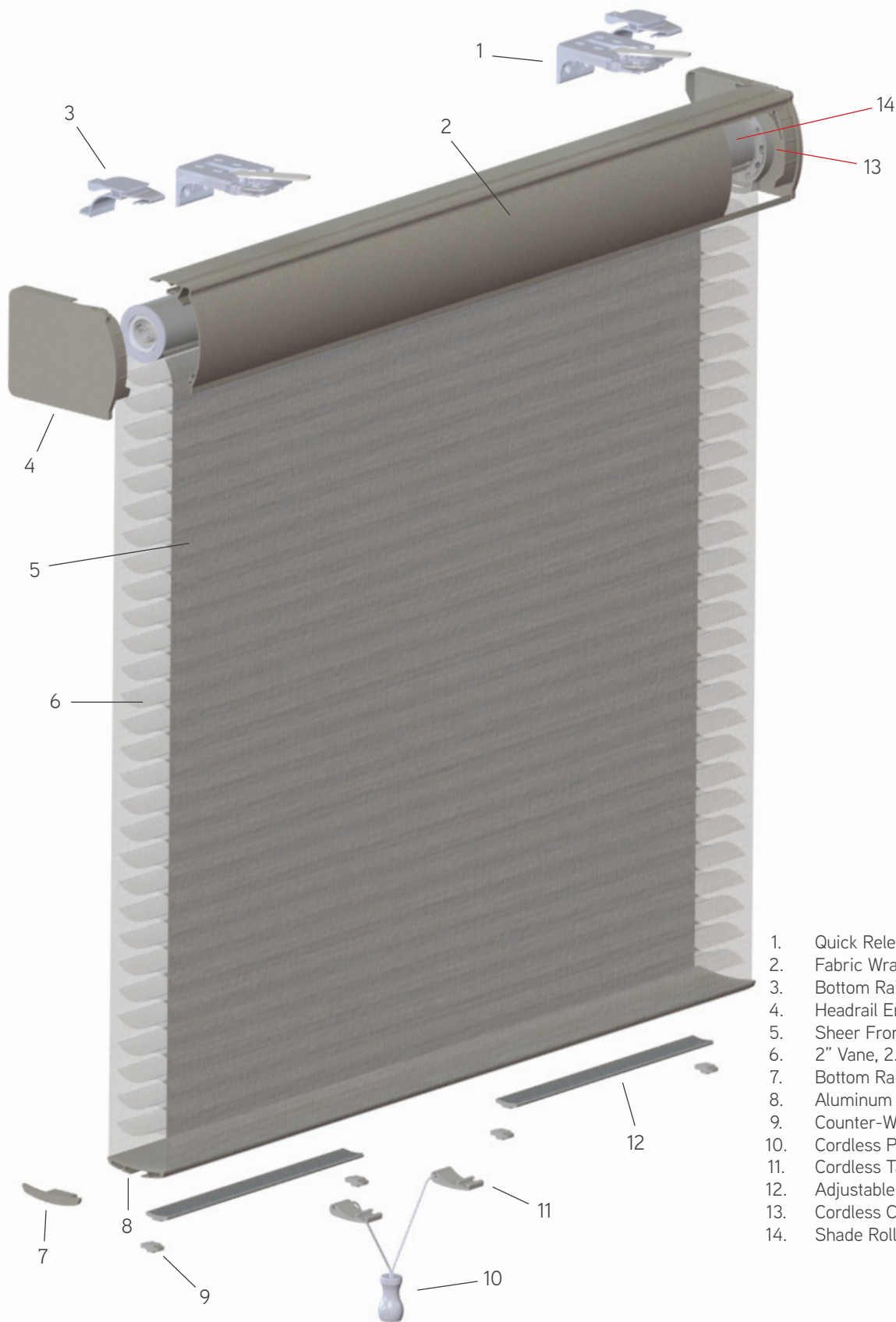

1. Quick Release Sheerview Brackets
2. Fabric Wrapped Aluminum Headrail
3. Bottom Rail Stopper
4. Headrail End Caps
5. Sheer Front Fabric
6. 2" Vane, 2.5" Vane, or 3" Vane
7. Bottom Rail Endcap
8. Aluminum Bottom Rail
9. Counter-Weight Lock Screw
10. Cordless Pull Down Tassel
11. Cordless Tassel Connecting Clip
12. Adjustable Bottom Rail Counter-Weight
13. Cordless Clutch Mechanism
14. Shade Roller Tube

# MOTORIZED SHEERVIEW SHADINGS

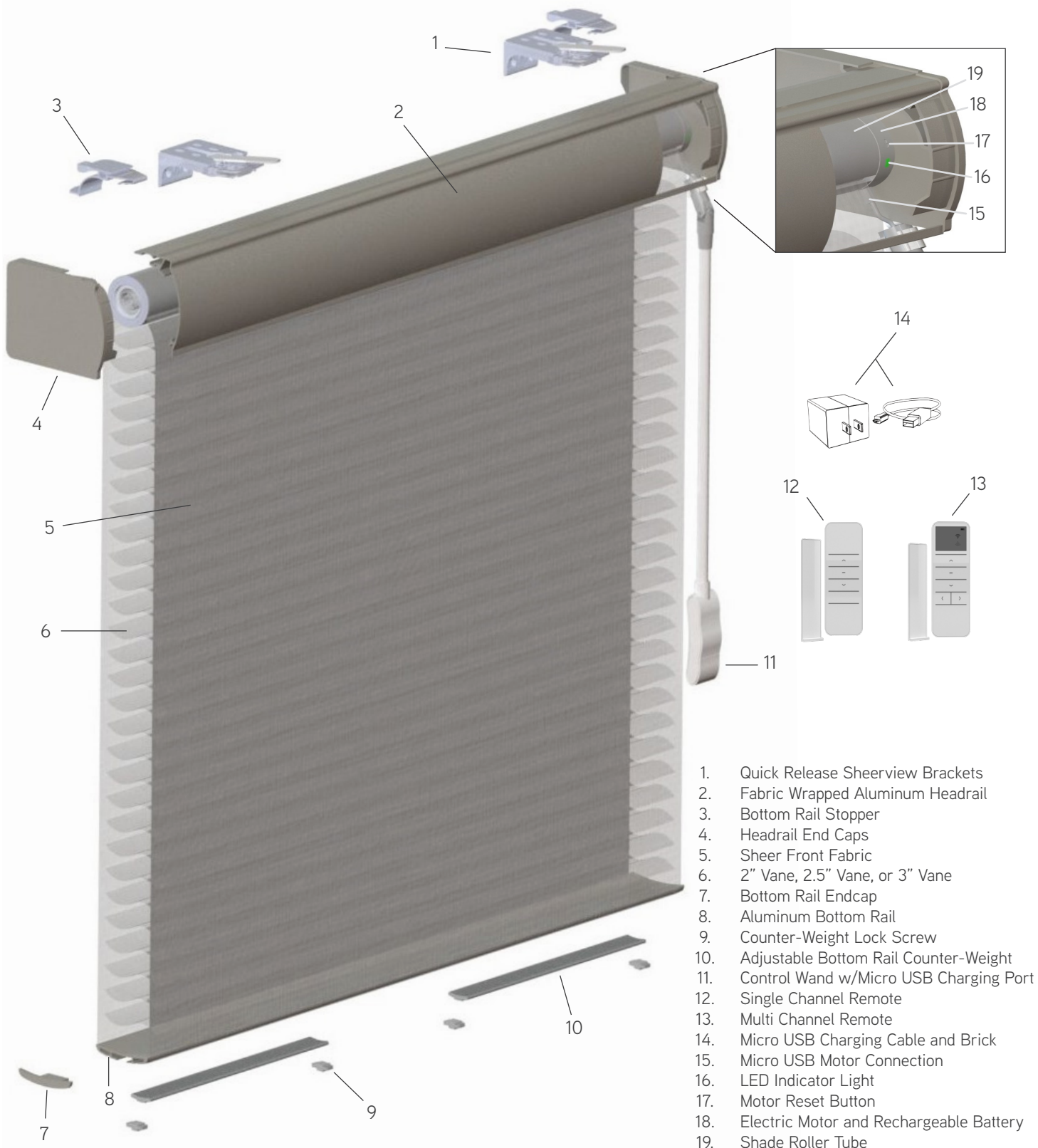

AVAILABLE IN TWO MOTOR OPTIONS  
**MOTORIZED WAND / REMOTE CONTROL**

TECHNOLOGY THAT ENHANCES  
 THE LIVING SPACE

**OPTION 1:** Rechargeable Motor with Wand Control

**OPTION 2:** Rechargeable Motor with Radio remote  
 Chip and Wand Control

- Easy Installation with no Hard Wiring
- Long Lasting Lithium Ion Battery
- Simple UP/DOWN/STOP Control Buttons
- Micro USB for Charging the Battery

WANDS	MSRP COST
Replacement Wand	\$176
CHARGING BRICK & USB CABLE	
Charging Brick & Micro Cable - 6'	\$65

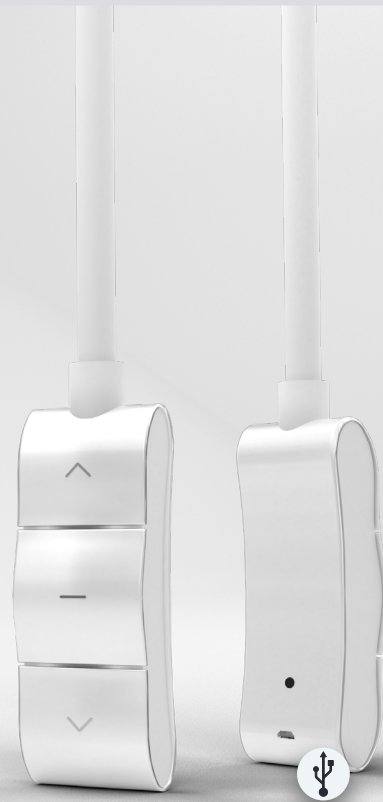

**REMOTE CONTROL - OPTIONAL**

(Must order motor with radio remote chip)

- Radio remote
- Control your shade with a single-channel or multi-channel remote from up to 100 feet away, with up to 20 shades per channel
- Remote attaches to backplate via magnets to mount in convenient location
- No pull cords for superior child and pet safety
- Sleek, modern design fits any decor

REMOTE	MSRP COST
Single Channel	\$127
Multi-Channel	\$159



Multi-Channel



Single Channel

# LIGHT FILTERING

SUGGESTED RETAIL PRICE

Heather (S65BN311), Blossom (S65BN206), Blush (S65BN312), Beige (S65BN322), Waterfall (S65BN627), Granite (S65BN823)

## 2.5" SHEER SHADE - NON WOVEN | PRINTED

Smallest width available 7.5" exact for manual shade  
Smallest width available 24" exact for Motorized shade

Height Up To	Width Up To												
	24"	32"	36"	42"	48"	54"	60"	66"	72"	84"	96"	108"	116"
36"	509	568	627	684	744	804	860	923	1067	1189	1310	1440	1655
42"	534	597	659	728	788	858	923	986	1135	1266	1397	1536	1765
48"	564	627	698	766	838	909	985	1056	1209	1346	1491	1639	1885
54"	583	658	733	810	889	965	1047	1129	1280	1427	1589	1748	2010
60"	607	693	772	853	931	1019	1107	1195	1341	1516	1690	1860	2139
66"	632	720	809	895	986	1079	1178	1268	1415	1609	1798	1978	2274
72"	659	752	845	939	1037	1139	1244	1341	1491	1692	1899	2089	2401
78"	674	777	876	976	1080	1188	1295	1405	1558	1777	1990	2189	2517
84"	702	809	910	1024	1136	1247	1368	1478	1637	1872	2096	2306	2652
90"	731	838	949	1069	1187	1313	1428	1551	1713	1960	2201	2420	2784
96"	756	874	989	1113	1244	1368	1497	1621	1793	2052	2303	2533	2913
102"	858	986	1117	1254	1384	1508	1676	1842	1965	2225	2479	2728	3137
108"	901	1035	1172	1319	1452	1585	1762	1932	2062	2338	2608	2869	3299
114"	954	1098	1241	1397	1545	1684	1867	2052	2189	2479	2766	3043	3497
120"	1019	1170	1331	1493	1643	1798	1994	2189	2339	2653	2955	3250	3738
132"	1172	1345	1530	1717	1890	2069	2292	2517	2691	3050	3398	3738	4299
144"	1347	1546	1760	1974	2173	2378	2638	2895	3094	3507	3908	4298	4943

Shades 93" or wider incur an additional net \$110.00 charge per box for each order (maximum 2 shades per box).

## VALANCE SURCHARGES

Architectural Square Valance Height 3.375"	25	35	45	55	65	75	85	95	105	115	125	135	145

## SYSTEMS UPGRADE RETAIL SURCHARGES

	Min Width	Max Width	Max Height
Safe Wand system: \$60	7.5 inches	116 inches	144 inches
Cordless system: \$106	20 inches	84 inches	84 inches
Motorization includes Wand: \$286	24 inches	116 inches	144 inches
Motorization using Remote: \$530			
Single Channel Radio Remote Control: \$127			
Multi-Channels Radio Remote Control: \$159			
USB 6' Cable with Charger: \$65			
Replacement Safe wand: \$176			
WiFi Bridge: \$778			
WiFi Hub Stick: \$430			

Smallest width available 7.5" exact for a manual SHEERVIEW SHADINGS. Smallest width available 24" exact for Motorized E-Series SHEERVIEW SHADINGS. Fabric Wrapped Headrail comes standard unless asked otherwise.

Shades 93" or wider incur an additional net \$110.00 charge per box for each order (maximum 2 shades per box).

# LIGHT FILTERING

SUGGESTED RETAIL PRICE

Bright White (S50PN100), Alabaster (S50PN112), Winter White (S50PN113), Beige (S50PN322), Blossom (S50PN206), Sesame (S50PN302), Java (S50PN378), Granite (S50PN823),

## 2" SHEER SHADE - NON WOVEN | SOLID

Smallest width available 7.5" exact for manual shade  
Smallest width available 24" exact for Motorized shade

Height Up To	Width Up To												
	24"	32"	36"	42"	48"	54"	60"	66"	72"	84"	96"	108"	116"
36"	443	493	545	595	647	699	748	802	928	1035	1138	1251	1440
42"	465	519	573	632	685	746	802	858	986	1101	1214	1335	1535
48"	491	545	607	666	729	790	857	920	1051	1170	1296	1426	1639
54"	507	572	636	704	773	840	909	982	1113	1242	1382	1521	1748
60"	529	602	670	741	810	887	963	1039	1166	1318	1471	1618	1860
66"	550	627	703	779	858	938	1023	1103	1231	1399	1563	1720	1978
72"	573	655	735	816	903	991	1082	1166	1296	1473	1651	1816	2089
78"	586	676	763	848	939	1034	1125	1221	1355	1545	1730	1903	2188
84"	612	703	791	891	987	1085	1190	1285	1424	1628	1823	2005	2305
90"	635	729	825	929	1032	1141	1243	1349	1490	1705	1914	2106	2420
96"	658	761	860	968	1082	1190	1301	1409	1559	1783	2003	2203	2533
102"	746	858	971	1091	1204	1312	1458	1601	1708	1935	2155	2372	2727
108"	783	900	1019	1147	1262	1377	1532	1681	1794	2033	2268	2495	2869
114"	829	953	1080	1214	1345	1464	1624	1783	1903	2155	2405	2645	3042
120"	887	1017	1157	1298	1429	1563	1735	1903	2035	2306	2570	2826	3250
132"	1019	1170	1331	1493	1643	1798	1994	2189	2339	2653	2955	3250	3738
144"	1172	1345	1530	1717	1890	2069	2292	2517	2691	3050	3398	3738	4299

Shades 93" or wider incur an additional net \$110.00 charge per box for each order (maximum 2 shades per box).

## VALANCE SURCHARGES

Architectural Square Valance Height 3.375"	25	35	45	55	65	75	85	95	105	115	125	135	145

## SYSTEMS UPGRADE RETAIL SURCHARGES

	Min Width	Max Width	Max Height
Safe Wand system: \$60	7.5 inches	116 inches	144 inches
Cordless system: \$106	20 inches	84 inches	84 inches
Motorization includes Wand: \$286	24 inches	116 inches	144 inches
Motorization using Remote: \$530			
Single Channel Radio Remote Control: \$127			
Multi-Channels Radio Remote Control: \$159			
USB 6' Cable with Charger: \$65			
Replacement Safe wand: \$176			
WiFi Bridge: \$778			
WiFi Hub Stick: \$430			

Smallest width available 7.5" exact for a manual SHEERVIEW SHADINGS. Smallest width available 24" exact for Motorized E-Series SHEERVIEW SHADINGS. Fabric Wrapped Headrail comes standard unless asked otherwise.

Shades 93" or wider incur an additional net \$110.00 charge per box for each order (maximum 2 shades per box).

# LIGHT FILTERING

SUGGESTED RETAIL PRICE

Bright White (S70PN100), Alabaster (S70PN112), Winter White (S70PN113), Luna (S70PN126), Beige (S70PN322), Blossom (S70PN206), Romance (S70PN323), Coastal Plain (S70PN503), Celadon (S70PN517), Sesame (S70PN302), Plank (S70PN371), Java (S70PN378), Granite (S70PN823), Rhinestone (S70PN824), Dusty Blue (S70PPN821),

Smallest width available 7.5" exact for manual shade  
Smallest width available 24" exact for Motorized shade

## 3" SHEER SHADE - NON WOVEN | SOLID

Height Up To	Width Up To												
	24"	32"	36"	42"	48"	54"	60"	66"	72"	84"	96"	108"	116"
36"	500	554	613	668	728	787	842	903	1044	1163	1280	1408	1619
42"	521	585	645	711	772	839	903	965	1111	1239	1366	1504	1728
48"	553	614	683	749	820	890	963	1034	1182	1316	1457	1603	1843
54"	571	644	716	793	869	943	1022	1104	1251	1395	1556	1711	1968
60"	595	678	753	833	910	996	1084	1169	1312	1482	1654	1821	2093
66"	617	704	792	877	965	1055	1153	1242	1384	1572	1759	1935	2224
72"	645	736	826	918	1016	1116	1215	1312	1457	1657	1858	2042	2348
78"	659	762	858	953	1056	1163	1267	1373	1524	1739	1947	2142	2462
84"	688	792	890	1002	1111	1219	1338	1446	1601	1831	2052	2256	2594
90"	715	820	928	1047	1162	1284	1398	1518	1676	1918	2152	2367	2723
96"	739	855	968	1089	1215	1339	1464	1586	1754	2007	2254	2480	2851
102"	839	966	1092	1229	1355	1475	1640	1800	1921	2177	2425	2667	3067
108"	880	1014	1146	1291	1420	1551	1723	1890	2019	2288	2550	2805	3226
114"	933	1073	1214	1366	1511	1647	1828	2005	2141	2425	2705	2976	3421
120"	998	1142	1300	1461	1607	1759	1951	2141	2288	2594	2890	3179	3657
132"	1146	1314	1495	1681	1849	2023	2243	2462	2630	2983	3324	3656	4204
144"	1318	1511	1720	1932	2126	2326	2581	2832	3026	3431	3823	4203	4836

Shades 93" or wider incur an additional net \$110.00 charge per box for each order (maximum 2 shades per box).

## VALANCE SURCHARGES

Architectural Square Valance Height 3.375"	25	35	45	55	65	75	85	95	105	115	125	135	145

## SYSTEMS UPGRADE RETAIL SURCHARGES

	Min Width	Max Width	Max Height
Safe Wand system: \$60	7.5 inches	116 inches	144 inches
Cordless system: \$106	20 inches	84 inches	84 inches
Motorization includes Wand: \$286	24 inches	116 inches	144 inches
Motorization using Remote: \$530			
Single Channel Radio Remote Control: \$127			
Multi-Channels Radio Remote Control: \$159			
USB 6' Cable with Charger: \$65			
Replacement Safe wand: \$176			
WiFi Bridge: \$778			
WiFi Hub Stick: \$430			

Smallest width available 7.5" exact for a manual SHEERVIEW SHADINGS. Smallest width available 24" exact for Motorized E-Series SHEERVIEW SHADINGS. Fabric Wrapped Headrail comes standard unless asked otherwise.

Shades 93" or wider incur an additional net \$110.00 charge per box for each order (maximum 2 shades per box).

# LIGHT FILTERING

SUGGESTED RETAIL PRICE

Winter White (S50KN113), Beige (S50KN322), Blossom (S50KN206), Linen (S50KN125), Java (S50KN378), Granite (S50KN823)

## 2" SHEER SHADE - WOVEN | SOLID

Smallest width available 7.5" exact for manual shade  
Smallest width available 24" exact for Motorized shade

Height Up To	Width Up To												
	24"	32"	36"	42"	48"	54"	60"	66"	72"	84"	96"	108"	116"
36"	466	519	572	625	680	734	785	842	975	1087	1195	1314	1511
42"	487	545	602	664	719	783	842	901	1035	1156	1276	1403	1612
48"	517	572	638	699	765	829	900	966	1103	1229	1360	1497	1721
54"	533	600	668	740	811	881	954	1031	1169	1303	1452	1596	1835
60"	555	632	704	779	852	930	1011	1091	1225	1384	1544	1699	1952
66"	577	659	739	817	901	984	1074	1158	1293	1470	1641	1806	2077
72"	602	687	772	857	947	1040	1136	1225	1360	1546	1734	1907	2193
78"	615	710	801	891	985	1086	1182	1282	1423	1622	1816	1999	2298
84"	643	739	830	935	1037	1139	1249	1350	1495	1709	1914	2105	2420
90"	667	765	865	976	1083	1198	1305	1416	1565	1790	2009	2211	2542
96"	691	799	904	1017	1136	1249	1366	1479	1637	1874	2102	2313	2660
102"	783	901	1020	1146	1264	1377	1530	1682	1794	2031	2264	2491	2864
108"	823	945	1070	1205	1325	1446	1609	1764	1883	2135	2381	2620	3012
114"	872	1001	1134	1276	1411	1539	1706	1874	1999	2264	2525	2778	3193
120"	930	1068	1215	1363	1501	1641	1821	1999	2136	2422	2697	2968	3413
132"	1070	1229	1398	1568	1725	1887	2094	2300	2457	2785	3102	3413	3925
144"	1231	1411	1606	1802	1984	2171	2408	2643	2825	3203	3567	3925	4515

Shades 93" or wider incur an additional net \$110.00 charge per box for each order (maximum 2 shades per box).

## VALANCE SURCHARGES

Architectural Square Valance Height 3.375"	25	35	45	55	65	75	85	95	105	115	125	135	145

## SYSTEMS UPGRADE RETAIL SURCHARGES

	Min Width	Max Width	Max Height
Safe Wand system: \$60	7.5 inches	116 inches	144 inches
Cordless system: \$106	20 inches	84 inches	84 inches
Motorization includes Wand: \$286	24 inches	116 inches	144 inches
Motorization using Remote: \$530			
Single Channel Radio Remote Control: \$127			
Multi-Channels Radio Remote Control: \$159			
USB 6' Cable with Charger: \$65			
Replacement Safe wand: \$176			
WiFi Bridge: \$778			
WiFi Hub Stick: \$430			

Smallest width available 7.5" exact for a manual SHEERVIEW SHADINGS. Smallest width available 24" exact for Motorized E-Series SHEERVIEW SHADINGS. Fabric Wrapped Headrail comes standard unless asked otherwise.

Shades 93" or wider incur an additional net \$110.00 charge per box for each order (maximum 2 shades per box).



# LIGHT FILTERING

SUGGESTED RETAIL PRICE

Winter White (S70KN113), Beige (S70KN322), Blossom (S70KN206), Linen (S70KN125), Java (S70KN378), Granite (S70KN823)

## 3" SHEER SHADE - WOVEN | SOLID

Smallest width available 7.5" exact for manual shade  
Smallest width available 24" exact for Motorized shade

Height Up To	Width Up To												
	24"	32"	36"	42"	48"	54"	60"	66"	72"	84"	96"	108"	116"
36"	524	581	644	701	764	826	885	947	1097	1221	1344	1478	1700
42"	547	614	677	746	810	880	947	1014	1166	1301	1434	1578	1814
48"	580	645	717	787	860	934	1011	1086	1242	1382	1529	1684	1934
54"	599	676	752	833	911	991	1073	1160	1314	1465	1634	1796	2067
60"	625	712	791	875	956	1047	1138	1228	1377	1557	1737	1912	2198
66"	648	740	832	922	1014	1108	1211	1303	1454	1651	1847	2031	2336
72"	677	773	867	963	1067	1171	1277	1377	1529	1740	1950	2144	2466
78"	692	800	901	1001	1109	1221	1331	1442	1600	1827	2044	2249	2586
84"	723	832	934	1052	1166	1281	1405	1519	1682	1923	2153	2369	2724
90"	751	860	975	1099	1219	1349	1469	1594	1761	2014	2259	2485	2858
96"	776	897	1017	1144	1277	1406	1539	1666	1842	2107	2366	2604	2994
102"	880	1015	1147	1291	1423	1549	1722	1890	2017	2286	2546	2801	3221
108"	925	1065	1204	1355	1491	1628	1810	1984	2119	2402	2677	2946	3387
114"	979	1127	1276	1434	1587	1729	1919	2105	2248	2546	2839	3124	3593
120"	1048	1199	1365	1534	1688	1847	2048	2248	2402	2724	3034	3338	3840
132"	1204	1380	1570	1764	1942	2124	2356	2586	2762	3133	3490	3839	4414
144"	1384	1587	1806	2028	2233	2443	2710	2973	3176	3601	4015	4413	5078

Shades 93" or wider incur an additional net \$110.00 charge per box for each order (maximum 2 shades per box).

## VALANCE SURCHARGES

Architectural Square Valance Height 3.375"	25	35	45	55	65	75	85	95	105	115	125	135	145

## SYSTEMS UPGRADE RETAIL SURCHARGES

	Min Width	Max Width	Max Height
Safe Wand system: \$60	7.5 inches	116 inches	144 inches
Cordless system: \$106	20 inches	84 inches	84 inches
Motorization includes Wand: \$286	24 inches	116 inches	144 inches
Motorization using Remote: \$530			
Single Channel Radio Remote Control: \$127			
Multi-Channels Radio Remote Control: \$159			
USB 6' Cable with Charger: \$65			
Replacement Safe wand: \$176			
WiFi Bridge: \$778			
WiFi Hub Stick: \$430			

Smallest width available 7.5" exact for a manual SHEERVIEW SHADINGS. Smallest width available 24" exact for Motorized E-Series SHEERVIEW SHADINGS. Fabric Wrapped Headrail comes standard unless asked otherwise.

Shades 93" or wider incur an additional net \$110.00 charge per box for each order (maximum 2 shades per box).

# ROOM DARKENING

SUGGESTED RETAIL PRICE

Bright White (S50PN100D), Beige (S50PN322D), Linen (S50PN125D), Java (S50PN378D), Granite (S50PN823D), Biscuit (S50PN145D), Cornsilk (S50PN414D)

## 2" SHEER SHADE - NON WOVEN | SOLID

Smallest width available 7.5" exact for manual shade  
Smallest width available 24" exact for Motorized shade

Height Up To	Width Up To												
	24"	32"	36"	42"	48"	54"	60"	66"	72"	84"	96"	108"	116"
36"	488	542	599	655	711	769	823	882	1020	1138	1251	1377	1584
42"	511	571	630	696	753	821	882	943	1085	1211	1335	1470	1689
48"	540	599	667	733	801	870	942	1011	1156	1286	1426	1568	1802
54"	557	629	701	775	850	924	1001	1081	1223	1365	1521	1672	1923
60"	581	663	738	815	891	975	1058	1142	1283	1450	1618	1779	2046
66"	605	691	774	857	943	1031	1127	1213	1354	1540	1720	1893	2176
72"	630	719	809	897	992	1090	1190	1283	1426	1620	1816	1998	2298
78"	645	744	839	934	1032	1136	1238	1345	1490	1700	1903	2094	2409
84"	671	774	871	979	1087	1194	1310	1413	1566	1790	2005	2206	2537
90"	699	801	908	1022	1135	1256	1366	1482	1639	1876	2106	2316	2662
96"	723	836	946	1065	1190	1310	1431	1551	1715	1961	2203	2424	2787
102"	821	943	1068	1200	1324	1442	1604	1761	1879	2129	2372	2608	2999
108"	861	989	1121	1262	1389	1516	1685	1848	1974	2236	2495	2744	3156
114"	912	1050	1186	1335	1478	1610	1787	1961	2094	2372	2645	2910	3347
120"	887	1119	1274	1428	1571	1720	1907	2094	2237	2537	2826	3109	3576
132"	1019	1286	1463	1641	1808	1978	2193	2409	2573	2918	3250	3576	4112
144"	1172	1479	1683	1889	2078	2274	2522	2769	2960	3354	3738	4112	4728

Shades 93" or wider incur an additional net \$110.00 charge per box for each order (maximum 2 shades per box).

## VALANCE SURCHARGES

Architectural Square Valance Height 3.375"	25	35	45	55	65	75	85	95	105	115	125	135	145

## SYSTEMS UPGRADE RETAIL SURCHARGES

	Min Width	Max Width	Max Height
Safe Wand system: \$60	7.5 inches	116 inches	144 inches
Cordless system: \$106	20 inches	84 inches	84 inches
Motorization includes Wand: \$286	24 inches	116 inches	144 inches
Motorization using Remote: \$530			
Single Channel Radio Remote Control: \$127			
Multi-Channels Radio Remote Control: \$159			
USB 6' Cable with Charger: \$65			
Replacement Safe wand: \$176			
WiFi Bridge: \$778			
WiFi Hub Stick: \$430			

Smallest width available 7.5" exact for a manual SHEERVIEW SHADINGS. Smallest width available 24" exact for Motorized E-Series SHEERVIEW SHADINGS. Fabric Wrapped Headrail comes standard unless asked otherwise.

Shades 93" or wider incur an additional net \$110.00 charge per box for each order (maximum 2 shades per box).

# ROOM DARKENING

SUGGESTED RETAIL PRICE

Bright White (S70PN100D), Beige (S70PN322D), Linen (S70PN125D), Java (S70PN378D), Granite (S70PN823D), Royal Blue (S70PN029D), Greek Villa (S70PN114D), Barcelona Beige (S70PN312D), Natural Tan (S70PN321D), Khaki (S70PN303D), Biscuit (S70PN145D), Cornsilk (S70PN414D), Lazy Gray (S70PN822D), Midnight (S70PN016D)

## 3" SHEER SHADE - NON WOVEN | SOLID

Smallest width available 7.5" exact for manual shade  
Smallest width available 24" exact for Motorized shade

Height Up To	Width Up To												
	24"	32"	36"	42"	48"	54"	60"	66"	72"	84"	96"	108"	116"
36"	550	610	674	735	800	864	926	992	1147	1280	1408	1549	1781
42"	574	644	709	782	848	923	992	1060	1221	1363	1504	1652	1901
48"	609	676	750	824	901	978	1058	1136	1300	1447	1603	1763	2027
54"	628	708	788	873	956	1038	1125	1215	1376	1534	1711	1882	2165
60"	655	746	829	917	1002	1095	1193	1285	1442	1632	1821	2001	2302
66"	679	775	872	965	1060	1161	1268	1365	1522	1730	1935	2128	2447
72"	709	810	909	1010	1118	1226	1336	1442	1603	1823	2042	2248	2583
78"	724	837	943	1050	1162	1280	1393	1511	1675	1913	2142	2355	2709
84"	757	872	978	1102	1221	1341	1473	1592	1761	2014	2256	2482	2853
90"	787	901	1020	1152	1278	1412	1537	1670	1845	2110	2367	2605	2995
96"	812	940	1065	1198	1336	1474	1610	1745	1930	2207	2480	2727	3137
102"	923	1063	1203	1351	1490	1622	1804	1981	2112	2394	2667	2934	3373
108"	968	1116	1261	1419	1562	1706	1897	2078	2220	2517	2805	3085	3549
114"	1026	1180	1335	1504	1663	1812	2010	2206	2354	2667	2976	3273	3763
120"	1097	1258	1430	1606	1769	1935	2146	2354	2517	2853	3179	3498	4022
132"	1261	1446	1646	1848	2035	2225	2468	2708	2894	3282	3656	4022	4625
144"	1450	1664	1892	2125	2339	2559	2838	3114	3328	3773	4203	4625	5320

Shades 93" or wider incur an additional net \$110.00 charge per box for each order (maximum 2 shades per box).

## VALANCE SURCHARGES

Architectural Square Valance Height 3.375"	25	35	45	55	65	75	85	95	105	115	125	135	145

## SYSTEMS UPGRADE RETAIL SURCHARGES

	Min Width	Max Width	Max Height
Safe Wand system: \$60	7.5 inches	116 inches	144 inches
Cordless system: \$106	20 inches	84 inches	84 inches
Motorization includes Wand: \$286	24 inches	116 inches	144 inches
Motorization using Remote: \$530			
Single Channel Radio Remote Control: \$127			
Multi-Channels Radio Remote Control: \$159			
USB 6' Cable with Charger: \$65			
Replacement Safe wand: \$176			
WiFi Bridge: \$778			
WiFi Hub Stick: \$430			

Smallest width available 7.5" exact for a manual SHEERVIEW SHADINGS. Smallest width available 24" exact for Motorized E-Series SHEERVIEW SHADINGS. Fabric Wrapped Headrail comes standard unless asked otherwise.

Shades 93" or wider incur an additional net \$110.00 charge per box for each order (maximum 2 shades per box).

# MEASURING

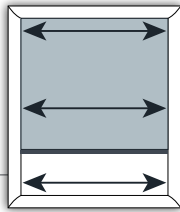

## INSIDE MOUNT WIDTH (IB)

- Measure the exact width of the inside edge of the window frame. - Top, Middle, and Bottom.
- Make all measurements to the nearest 1/8th inch, round DOWN for width.
- Take the SMALLEST of the 3 measurements, this is the width that you will order.
- Production department will make the necessary deductions to ensure the shade fits inside your window.

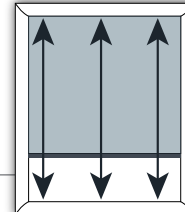

## INSIDE MOUNT HEIGHT (IB)

- Measure the exact height from the top inside edge down to the window sill in 3 places. - Left, Middle, Right
- Make all measurements to the nearest 1/8th inch, round UP for height.
- Take the LARGEST of the 3 measurements, this is the height that you will order.

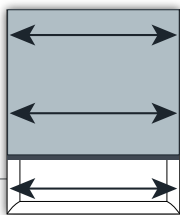

## OUTSIDE MOUNT WIDTH (OB)

- Measure the exact width of the window frame or how wide you would like the shade to be.
- Be sure to measure wide enough to cover the entire window (and trim if desired) to provide maximum light coverage.
- Example: If the window opening is 36" wide, it might be helpful to order 40" if the space allows. This will provide 2" coverage on each side of the window.
- No deductions/additions will be made to the width ordered.

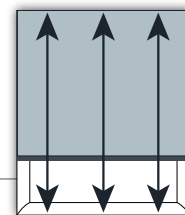

## OUTSIDE MOUNT HEIGHT (OB)

- Measure the height you would like the shade to be by measuring top to bottom.
- Be sure to measure high enough to cover the entire window (and trim if desired) to provide maximum light coverage.
- Example: If the window opening is 60" high, it might be helpful to order 64" if the space allows. This will provide 2" coverage on top and bottom of the window.
- No deductions/additions will be made to the height ordered.

# MISCELLANEOUS INFORMATION

## CLEANING AND CARE INFORMATION

SHEERVIEW SHADINGS are uniquely low-maintenance, needing only periodic vacuuming on a low setting and occasional feather dusting. The sheer fabric may also be ultrasonically cleaned.

## FINISHED DIMENSIONS

Once ordered and manufactured, the width of the fabric cannot be altered. The Manufacturer makes deductions to the width of window shadings depending on the type of mounting indicated. For all mounting types, the fabric will measure exactly the length ordered when the vanes are in the open or “view-through” position. When the vanes are rotated to the closed position, the shading will become 3/8” longer.

**IB Deductions:** Headrail will measure ordered width minus 1/8”, fabric will measure ordered width minus 15/16”

**OB Deductions:** Headrail will measure ordered width, fabric will measure ordered width minus 13/16”

## MEASUREMENT CONSIDERATIONS

When closed on an inside mount, a slight furrow may occur on the lowermost sheer section because of contact with the sill. To compensate, slightly raise the shading until the rail begins to lift off the window sill.

If preferred, the shading can be ordered 3/8” less than the measured height of the window opening. In this case, the bottom rail will be positioned 3/8” above the sill when the vanes are in the open position. Rotating the vanes closed will cause the bottom rail to touch the window sill and thus closing any unwanted space.

## HEADRAIL INFORMATION

### INSIDE MOUNT

Minimum depth for flush inside mount including installation brackets: 3 1/4”

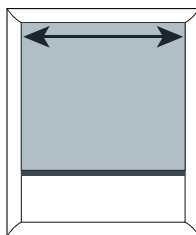

### OUTSIDE MOUNT

Minimum surface area required for mounting: 3/4”

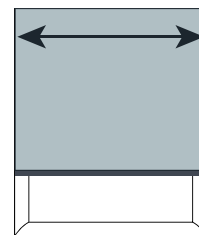

# PRODUCT OPERATION

## SHADING OPERATION

The SHEERVIEW SHADINGS Horizontal Sheer Shade features a control system with the ability to manipulate the shading into various viewing positions. From the closed and retracted position (fabric inside the headrail), lower the fabric by pulling down on the rear of the cord until you reach the desired shading position. Once lowered completely to the window sill, continuing to pull the cord in the same direction will open the horizontal fabric vanes, offering varied views to the outside. To retract the shading, pull down on the front of the cord until the shading reaches the desired viewing mode or fabric position. Shade will not tilt open unless fully lowered.

## HARDWARE

- **Installation Headrail Brackets**  
Multi-faceted bracket system includes breakaway shims to assist in leveling. The bracket also includes easy release lever.
- **Spacer Blocks** - Upon Request Only  
Spacer blocks project the shading  $3/8$ " from the mounting surface. Use spacer blocks to obtain clearance when obstructions, such as window cranks or door handles, obstruct the movement of shading.
- **Hold Down Brackets** - Upon Request Only  
Hold down brackets are made of clear plastic that fit into holes on the end-cap of the bottom rail. Hold downs are generally used to secure the base of the window shading to prevent swaying.

## SKEW ADJUSTING BOTTOM RAIL

The SHEERVIEW SHADINGS Horizontal Sheer Shades are leveled and weighed in the factory. When installed level, the fabric will not skew when raised. If the headrail is not installed level, skewing can occur that can damage the edge of the fabric. Be sure to follow the instructions below carefully to ensure correct and balanced operation.

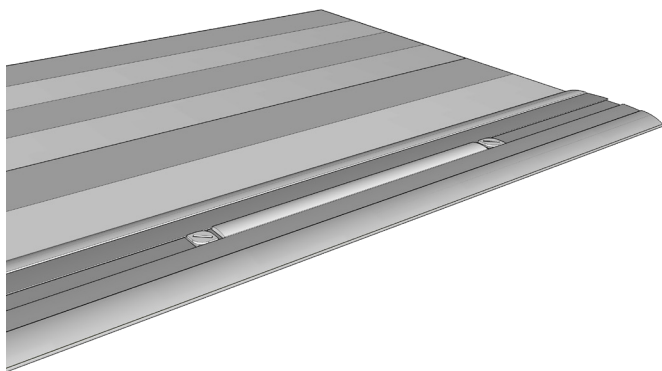

Turn over the bottom rail use a flat head screwdriver to twist both stoppers on the left and right side of the counterweight slide.

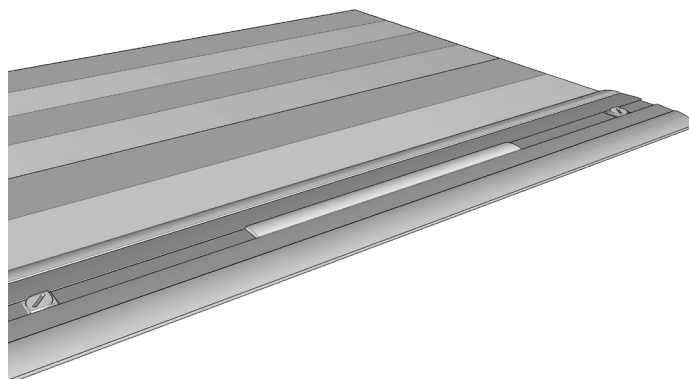

Slide the bar to where the counterweight is needed to combat the shifting of the shades. Twist down with a flathead screwdriver on both stoppers in order to re-lock the counterweights.

# PROGRAMMING INFORMATION

PLEASE KEEP IN MIND THAT OUR E-SERIES PRODUCTS COME PREPROGRAMMED FROM THE FACTORY SPECIFICALLY FOR YOUR WINDOW HEIGHTS AND TO YOUR MOTOR. THIS INFORMATION SHOULD ONLY BE USED IF THE PROGRAMMING HAS BEEN ACCIDENTALLY ERASED OR AT THE ADVICE OF THE MANUFACTURER. PLEASE UNDERSTAND THAT TECHNICAL SUPPORT IS AT THE DISCRETION OF THE MANUFACTURER IN CASES OF UNAUTHORIZED SYSTEM RESETS.

## PAIRING A WIRELESS REMOTE (ONLY IF YOUR MOTOR WAS ORDERED WITH THE WIRELESS UPGRADE)

To pair a wireless remote, press and hold the reset button using a paperclip on the back of the wand for approximately 3 seconds looking for the shade to jog once and beep once.

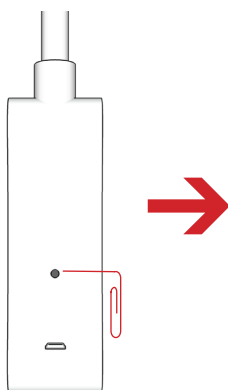

Immediately after the jog and beep press the up button once on your wireless remote and the shade will jog once and beep 3 times confirming pairing success. If using a multi-channel remote make sure to have the desired channel selected prior to starting the process.

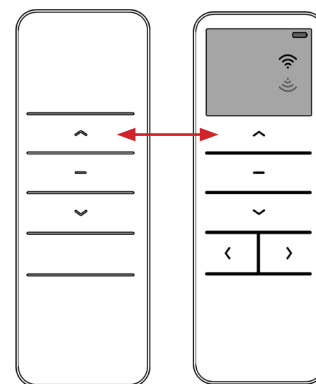

## SETTING/ADJUSTING LIFT HEIGHTS

If the shade has been reset, the lift heights have been reset as well. Use the process below to set new lift heights. If an adjustment needs to be made to existing lift heights the process below is the same except you will need to enter "Adjustment Mode". To enter adjustment mode for the top height, press and hold the Up and Stop buttons together for 10 seconds looking for a single jog. To enter the adjustment mode for the bottom height press and hold the Down and Stop buttons together for 10 seconds looking for a single jog.

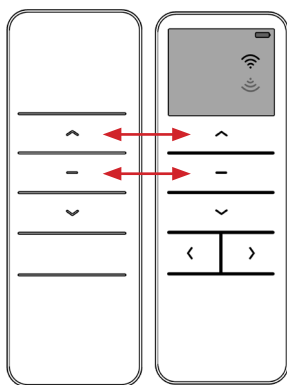

### TOP HEIGHT

Bring the shade to the position at the top nearest to the headrail that you would like to be the top height. You may have to stop the shade manually with the stop button. Press and hold the Up and Stop buttons together for about 3 seconds looking for shade to jog twice and beep once confirming the top height being set. This process can also be performed on the control wand.

### BOTTOM HEIGHT

Bring the shade to the position at the bottom nearest to the window sill that you would like to be the bottom height. You may have to stop the shade manually with the stop button. Press and hold the Bottom and Stop buttons together for about 3 seconds looking for shade to jog twice and beep once confirming the bottom height being set. This process can also be performed on the control wand.

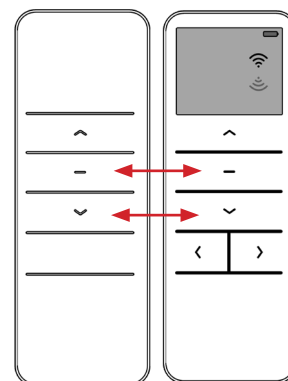

# THE IMPORTANCE OF ORDERING CORRECTLY FROM THE MANUFACTURER

Place your order correctly with the manufacturer to decrease the need for remakes, refunds or returns.

### IMPORTANT ORDERING INFORMATION:

- You must include ACCURATE measurements for the width and height (to the nearest 1/8") of the product
- You must specify IB or OB mounting required of the product
- You must include the color name, and color number
- You must include position of lift - LEFT or RIGHT

### FABRIC STYLE & COLOR SELECTION

Woven and Non Woven fabrics come in Light filtering and Room Darkening. Choose from the colors available.

Example Color Number: **S50PN100D**

- 2" - S50
- 2.5" - S65
- 3" - S70
- Non Woven - PN
- Woven - KN
- Printed - BN
- Color # - 100
- Room Darkening - D

**REMAKES:** We understand mistakes happen and typically your per-negotiated Ops discount may apply.

**REFUNDS:** May be issued at the manufactures discretion.

**RETURNS:** Dealer must contact the manufacturer directly to obtain and return authorization.

TO FIND YOUR COST							
Height Up To	Width Up To →						
	24"	32"	36"	42"	48"	54"	
36"	410	457	504	550	599	647	
42"	429	480	530	585	634	690	
48"	455	504	562	616	674	731	
54"	469	529	589	652	715	777	
60"	489	557	621	<b>686</b>	750	820	
66"	508	580	651	720	794	867	
72"	530	606	680	755	835	917	

After finding your price based on fabric size add any additional upgrade surcharges you are purchasing to total price of the shade.



# MANUFACTURER TERMS AND CONDITIONS

- Catalog prices (USD) and product specifications are subject to change without notice.
- All materials are subject to dye lot variations.
- Manufacturer will not assume responsibility for any color mismatch after subsequent orders.
- For any product the manufacturer performs warranty service on, transportation charges are not included in warranty.
- State Tax Exemption Certificates must be provided and on file for tax exempt sales production.
- There will be a nominal service charge for changes or cancellations made after production has started.
- The manufacturer is not responsible for printing or typographical errors within the catalog, website or other published information.
- Manufacturer currently ships with most major carriers.
- Returns must have an RGA Number and be approved.
- Claims for merchandise shortages, damages or discrepancies must be made within 10 days of the receipt of goods.
- These SHEERVIEW SHADINGS are custom made and cannot be canceled once the order has been made.



# WARRANTY

This Limited Lifetime Warranty program is available to consumers who have purchased blinds and shades by (The Manufacturer). This applies to Fabric Horizontal Blinds, Sheer Shades, Roman Shades, Cellular Shades, Pleated Shades, and painted or stained valances.

This warranty is effective November 1st, 2023. Product bought prior to effective date will be subject to warranty in place at time of original purchase.

## What the Warranty Covers

The manufactured product is warranted against original defects in materials, workmanship or failure to operate for as long as the **original** purchaser owns the product (unless shorter time periods are provided below) on the conditions that;

- The product was properly installed in a residential or commercial dwelling
- The product was made or assembled exclusively from Lantex USA, LLC. materials and components
- The Manufacturer recommendations were followed regarding limitations and specifications
- The Manufacturer componentry are covered for 5 years
- The Manufacturer motorized components are covered for 2 years

## Who is Covered

This warranty extends only the ORIGINAL purchaser of the above stated products.

The Manufacturer obligations to the Consumer are limited to the repair or replacement of parts or products found to be defective. The Manufacturer is not responsible for shipping charges or labor costs, for measuring and taking the product down or for remeasuring or reinstalling the product. Defects in product found on arrival must be reported within 10 days of delivery date confirmed by the shipping company. If not the product will be remade at full cost to the consumer.

If repairs are made under this warranty, the repairs will be made with like or similar parts.

## TO RECEIVE WARRANTY SERVICE, PLEASE:

1. Contact our Customer Service department at (605) 999-2267 and advise them of the nature of the issue. Customer Service will provide you with information as to how to proceed.
2. Please remember, product returned for warranty claims must be accompanied by the original sales receipt as well as written details regarding the nature of the problem, location of the product, etc.
3. All remake requests will need a picture or video supporting the claim before being approved.
4. If your product is returned, please retain a copy of the shipping information for your records.

## What the Warranty Does Not Cover

This warranty does not cover conditions or damages caused by abuse, accidents, alterations, misuse, or failure to follow instructions for measurement, installation, use, cleaning, or maintenance. Normal wear and tear, including but not limited to the items or occurrences below, is not covered by the warranty:

- Batteries.
- Unfinished cornices.
- All fabrics can lose original intensity after long exposure to the sun. When left for extended periods in direct sunlight, plastics tend to yellow or crack. Some loss of color intensity or discoloration may occur in plastic materials or wood finishes.
- Colors may vary from lot to lot and may not exactly match samples of previous purchases.

THE MANUFACTURER CONSIDERS THESE ITEMS OR OCCURRENCES NORMAL WEAR AND TEAR, AND THEY ARE NOT COVERED BY THIS WARRANTY. THIS WARRANTY IS EXCLUSIVE AND IN LIEU OF ALL OTHER WRITTEN OR ORAL WARRANTIES OR OBLIGATIONS AND LIABILITIES. NO PERSON IS AUTHORIZED TO EXTEND OR ALTER THIS WARRANTY. THE MANUFACTURER SHALL HAVE NO LIABILITY WHATSOEVER FOR INCIDENTAL OR CONSEQUENTIAL DAMAGES. SOME STATES DO NOT ALLOW THE EXCLUSION OR LIMITATION OF INCIDENTAL OR CONSEQUENTIAL DAMAGES, SO THIS LIMITATION OR EXCLUSION MAY NOT APPLY TO YOU.

# Sheerview Shadings



(605) 999-2267

/

[www.westernwc.info](http://www.westernwc.info)

/

[orders.westernwc@gmail.com](mailto:orders.westernwc@gmail.com)

2024